

Completing the NM Broadband Highway



Wired For Success

# Statewide Education Network & Broadband Update



Subscribe to New Mexico Broadband Connections

# What is the Statewide Education Network (SEN)?

- <https://youtu.be/WgdkZjFmVUY>

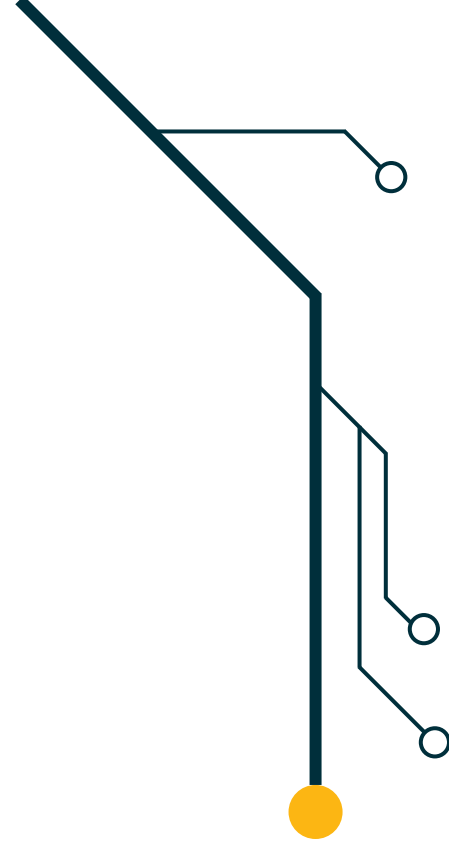

# SEN Phase 1 (& beyond) – Overview & Cost

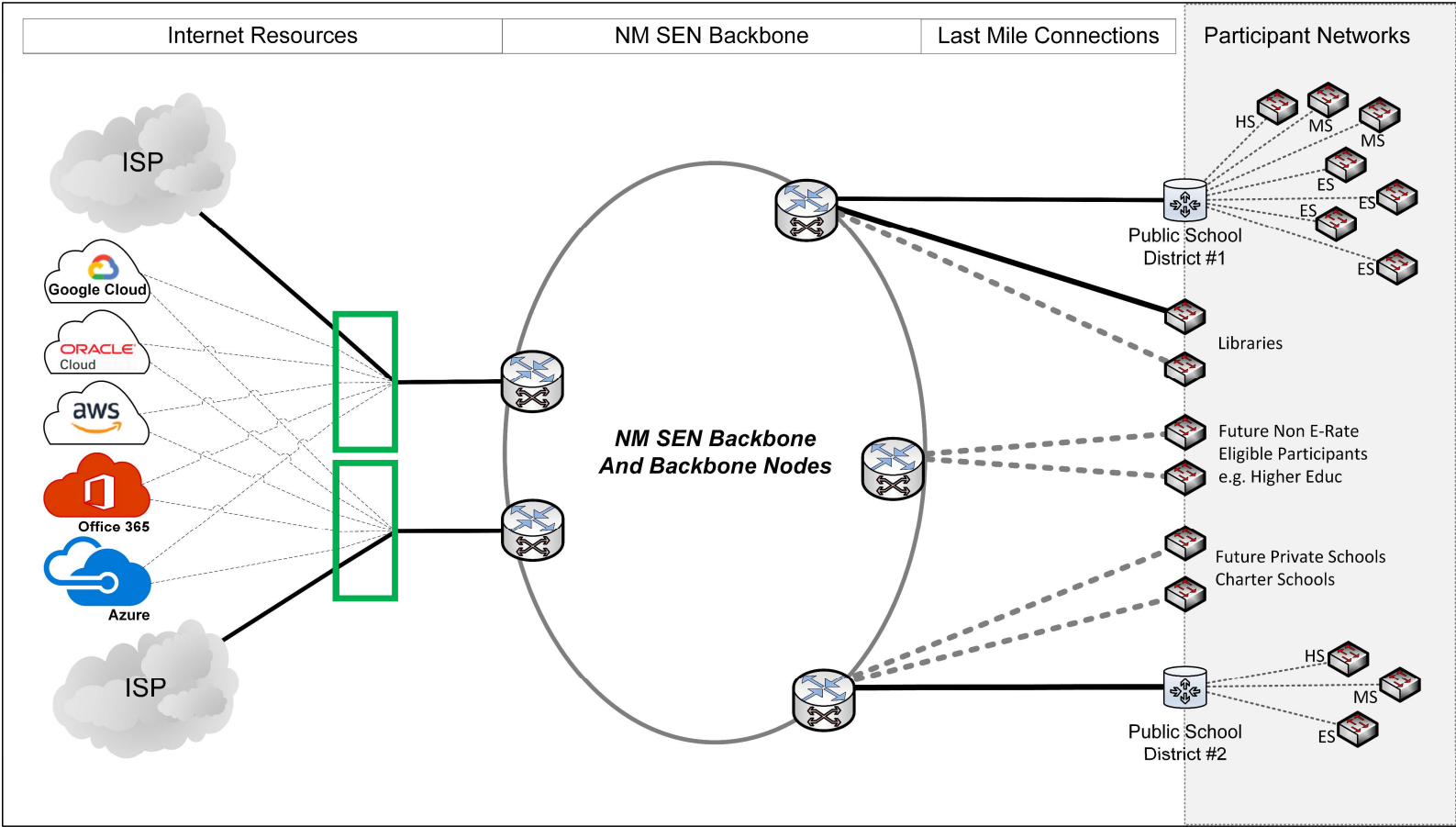

# Completing the NM Broadband Highway

## SEN Nodes

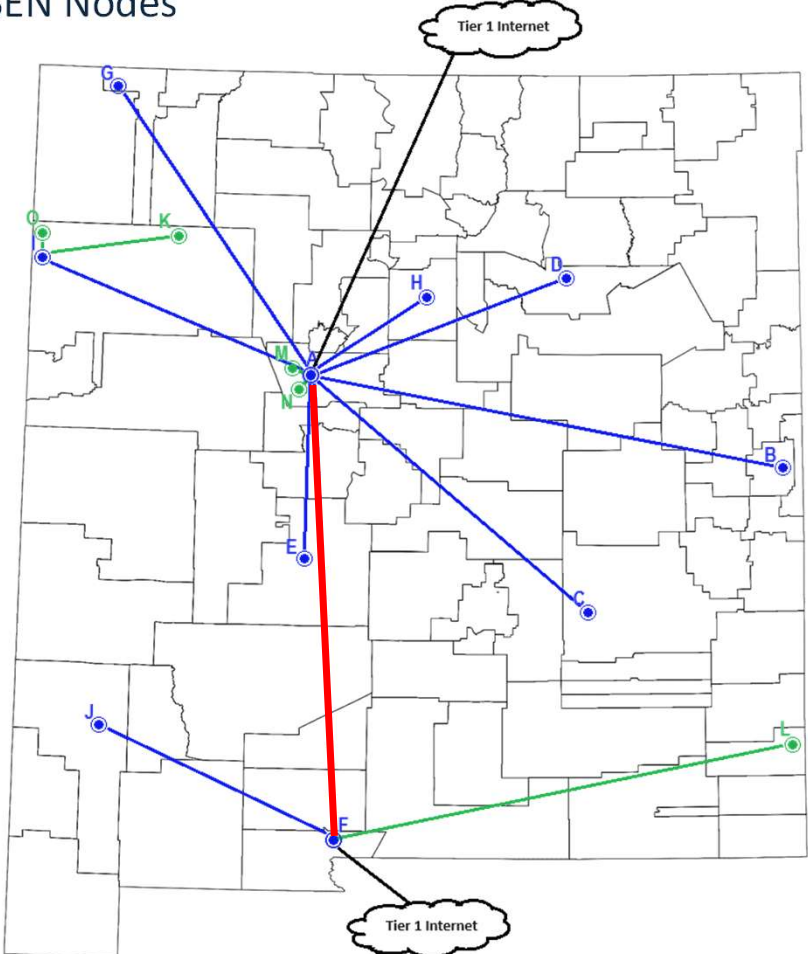

**Existing Nodes:**

- A - Albuquerque (505Marquette)
- B - Clovis (Clovis Community College)
- C - Roswell (Eastern NM University)
- D - Las Vegas (Highlands University)
- E - Socorro (New Mexico Tech)
- F - Las Cruces (New Mexico State University)
- G - Farmington (San Juan College)
- H - Santa Fe (Santa Fe Indian School)
- I - Gallup (UNM Gallup)
- J - Silver City (Western NM University)

**Potential New Nodes:**

- K - Crownpoint (Navajo Technical University)
- L - Hobbs (New Mexico Junior College)
- M - Albuquerque (OSO internet Exchange)
- N - Las Vegas (Highlands University)
- O - Yah-Ta-Hey Neutral Aggregation
- Raton
- Taos
- ...

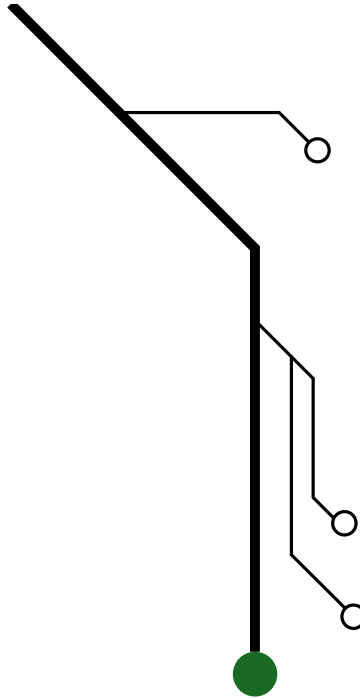

# Completing the NM Broadband Highway

## Last mile Participants

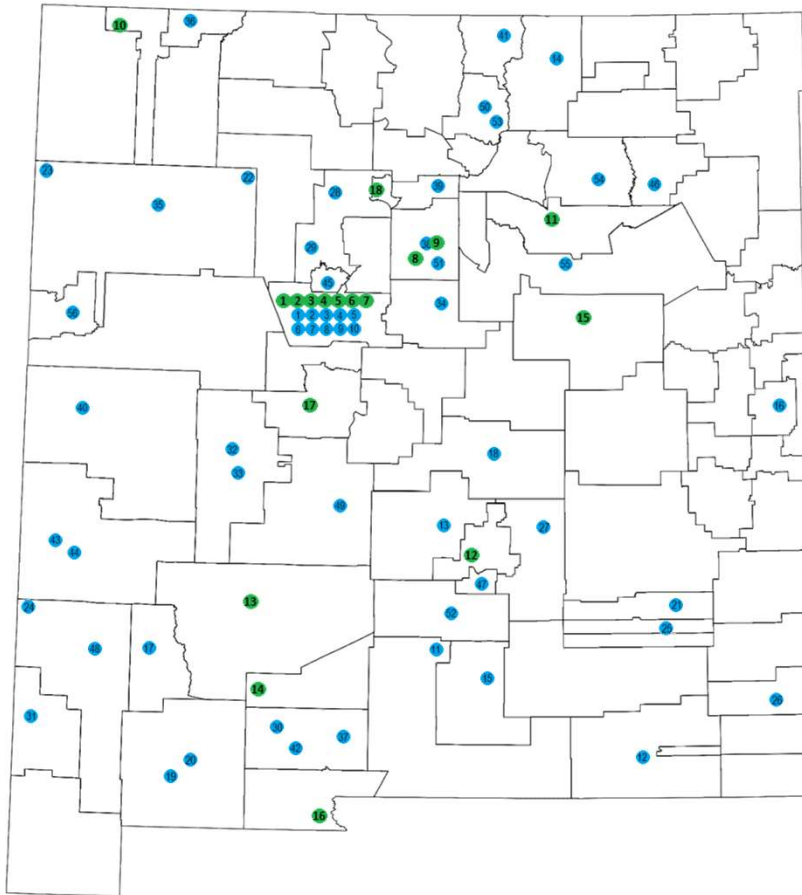

### Phase 1

- 1 Dorn Charter School\*
- 2 Mark Armijo Academy
- 3 APS Data Center
- 4 Coral Cmty Charter School\*
- 5 Albuquerque School of Excellence
- 6 21st Century Public Academy
- 7 Mountain Mahogany Cmty School
- 8 Monte Del Sol Charter School
- 9 Santa Fe Public Schools
- 10 Farmington District Office
- 11 Las Vegas City Schools Data Center
- 12 Capitan Schools\*

### Phase 2

- 1 Albuquerque Sign Language Academy
- 2 Amy Biehl High School
- 3 Cien Aguas International School
- 4 Cottonwood Classical Prep School
- 5 Gordon Bernell Charter School
- 6 Health Leadership High School
- 7 La Academia De Esperanza
- 8 Los Puentes Charter School
- 9 New Mexico International School
- 10 Technology Leadership High School
- 11 Alamogordo Public School District
- 12 Carlsbad Municipal Schools
- 13 Carrizozo Municipal Schools
- 14 Cimarron Mun School District
- 15 Cloudcroft Mun School District
- 16 Clovis Municipal Schools
- 17 Cobre Consolidated School District
- 18 Corona Public Schools
- 19 Deming Cesar Chavez High School
- 20 Deming Data Center
- 21 Dexter School District
- 22 Diné College Tribal Library
- 23 DEAP
- 24 Glenwood Library
- 25 Hagerman Municipal School District
- 26 Hobbs Municipal School District
- 27 Hondo Valley School District
- 28 Jemez Mountain (NCC)
- 29 Jemez Valley (NCC)
- 30 Las Cruces Public Schools
- 31 Lordsburg Municipal Schools
- 32 Magdalena Elementary School
- 33 Magdalena Library
- 34 MESD Network Operations
- 35 Middle College High School
- 36 Mosaic Academy
- 37 New America School - Las Cruces
- 38 New Mexico School For The Deaf
- 13 Truth or Consequences Data Center
- 14 Hatch Valley Schools
- 15 Santa Rosa Schools
- 16 Gadsden Administrative Center
- 17 Belen Schools
- 18 Los Alamos Schools
- 39 Pojoaque Central Office
- 40 Quemado Independent School District
- 41 Questa High School
- 42 Raices del Saber Xinachtli School
- 43 Reserve Independent Schools
- 44 Reserve Library
- 45 Rio Rancho Public Schools
- 46 Roy Municipal Schools
- 47 Ruidoso High School
- 48 Silver Consolidated Schools
- 49 Socorro Data Center
- 50 Taos Academy Charter School
- 51 Tierra Encantada Charter School
- 52 Tularosa Municipal School District
- 53 Vista Grande High School
- 54 Wagon Mound Public Schools
- 55 West Las Vegas School District
- 56 Zuni Public School District

\* Removed from project due to school closure or school opting to receive internet services differently.

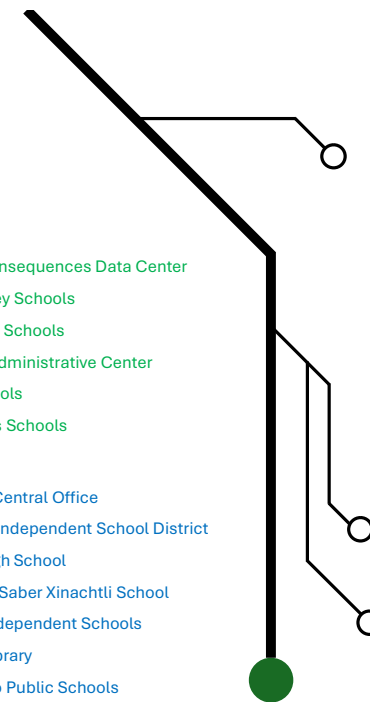

# School Connection Options

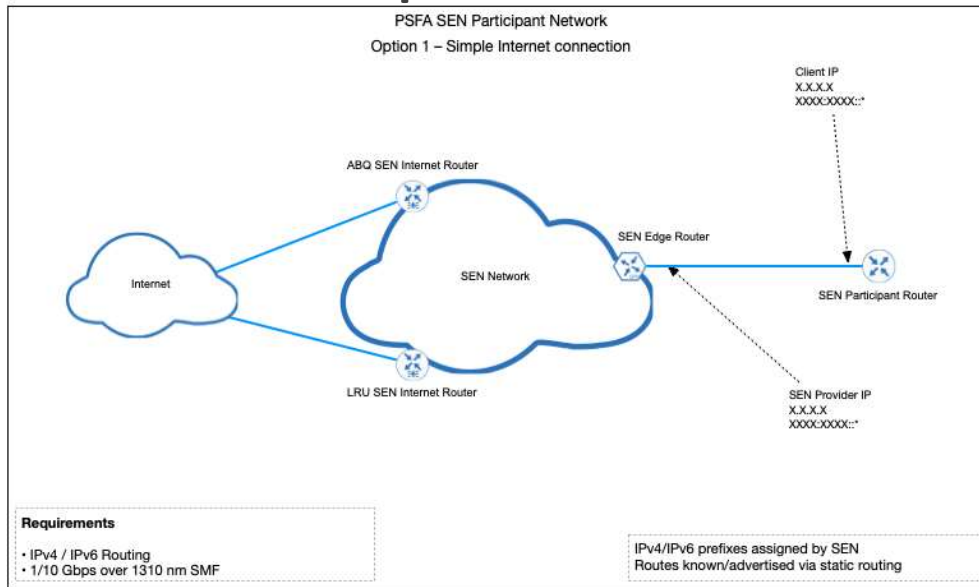

Option 1:  
Available today

Options 2-4:  
Available in near future

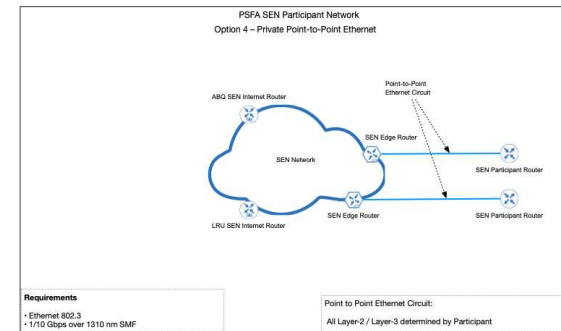
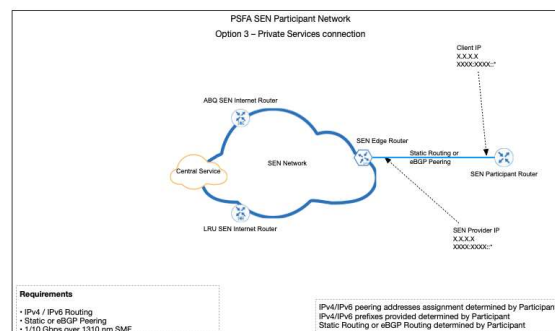
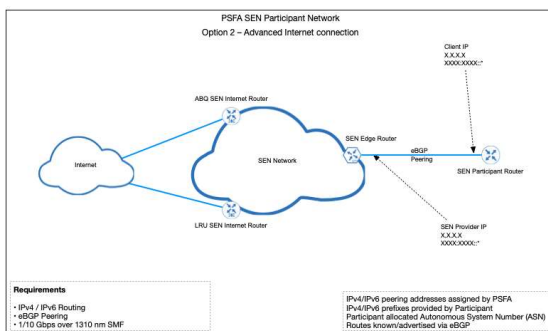

Completing the New Mexico Broadband Highway

# Potential Central Service(s)

## Define Central Service(s):

- Books (instruction)
- Videos
- Lesson Plans
- Online Classes
- Online tutoring
- Health & Wellness
- Professional development materials
- Learning platforms
- Cloud
- Cybersecurity
- Etc....

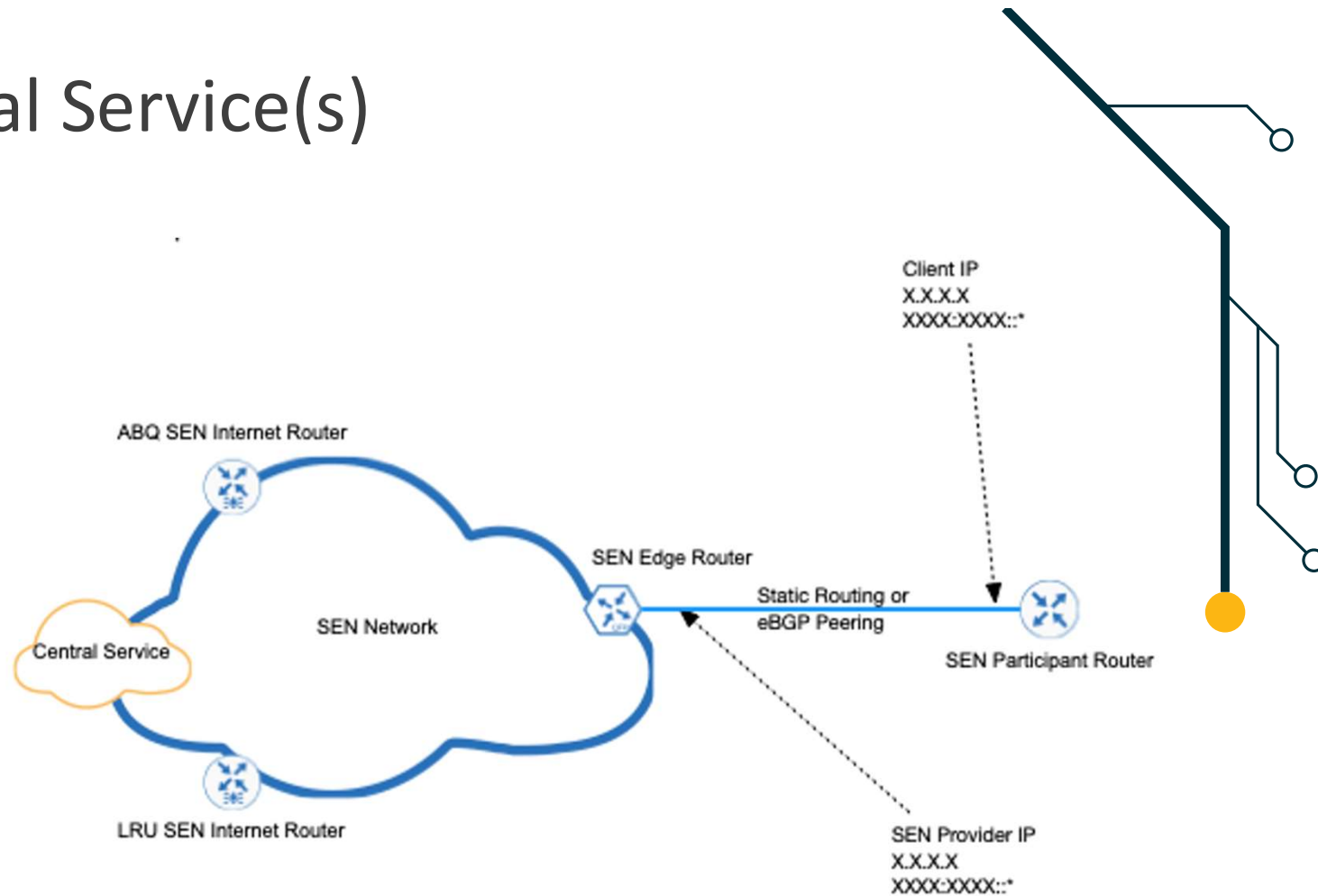

## SEN Summary:

- Capable tool to help advance instruction
- Can help with many issues: education / technical / security / financial
- Operational today
- E-rate (Phase1) funding approved (sustainability)
- Within current budget even without E-rate (financial resiliency)
- Mission Critical Operation (24x7x365)
- 10+ Hub Sites / 100s of sites & customers & ~500,000 users

