



ALLIANCE
FOR AUTOMOTIVE
INNOVATION



New Mexico Transportation Infrastructure Revenue Subcommittee

Transformation of the Auto Industry

Curt Augustine – Senior Director, State Affairs

July 24, 2024





• APTIV •



Autoliv

BASF
We create chemistry

BMW GROUP

BOSCH

cruise

DENSO



HONDA



INEOS
Automotive



ISUZU



LUMINAR



nuro

Panasonic

PORSCHE

Qualcomm



STELLANTIS



TOYOTA

Uber



VOLKSWAGEN
GROUP OF AMERICA

VOLVO



Automakers are committed to an electrified future

Types of Electric Vehicles (PHEVs, BEVs, FCEVs)

- Plug-In Hybrid Electric Vehicles (PHEVs) - XC60 T8, Clarity, RAV4 Prime, Wrangler 4xe)



- Battery Electric Vehicles (BEVs - LEAF, Bolt, ID.4, F150, i5, MX 30, EV6, EQS)



- Hydrogen Fuel Cell Electric Vehicles (FCEVs - Mirai, Nexso)



The Future Is Electric

ELECTRIC VEHICLE & BATTERY PRODUCTION AND R&D LOCATIONS

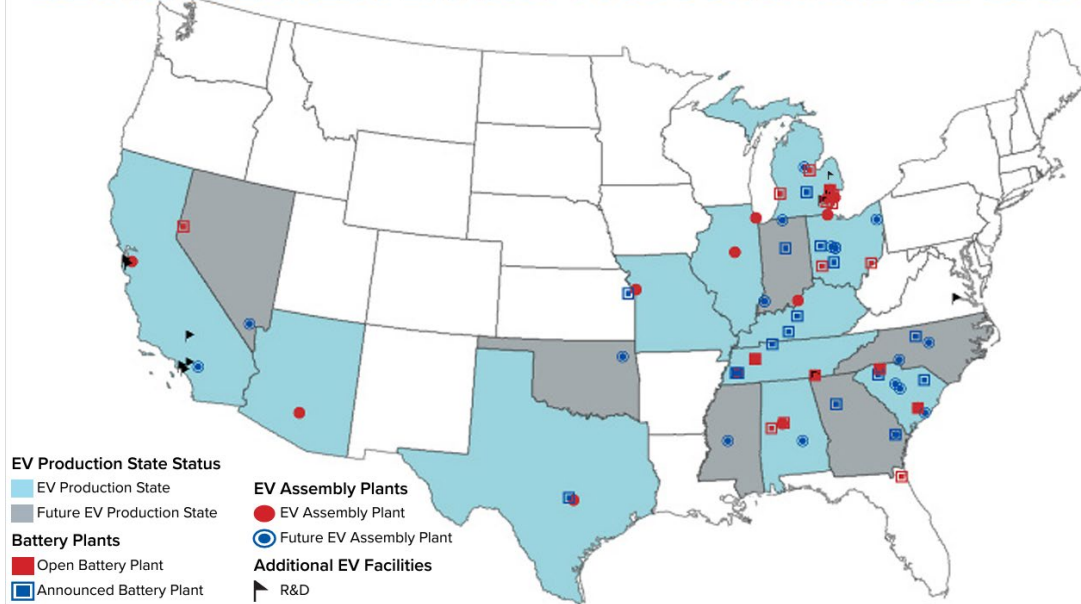

With the right complementary policies in place, the auto industry is poised to accept the challenge of driving EV purchases to between 40 and 50 percent of new vehicle sales by the end of the decade.

-Auto Innovators (Aug. 5, 2021)

- \$125+ Billion in U.S. Investment by autos and battery partners since 2017
- \$1.2 Trillion Global EV Investment by 2030
- U.S. Battery plant manufacturing capacity set to grow 649% by 2025

National EV Sales: 2020 – 2024 (Q1)

In the first quarter of 2024, about 344,000 electric vehicles (EVs, including battery, plug-in hybrid, and fuel cell electric vehicles) were sold in the United States, representing 9.3 percent of overall light-duty vehicle sales. This represents a 0.9 percentage point market share decrease over the fourth quarter of 2023 and a decrease of about 33,000 vehicle sales.

EV Market Share: January 2020 - March 2024

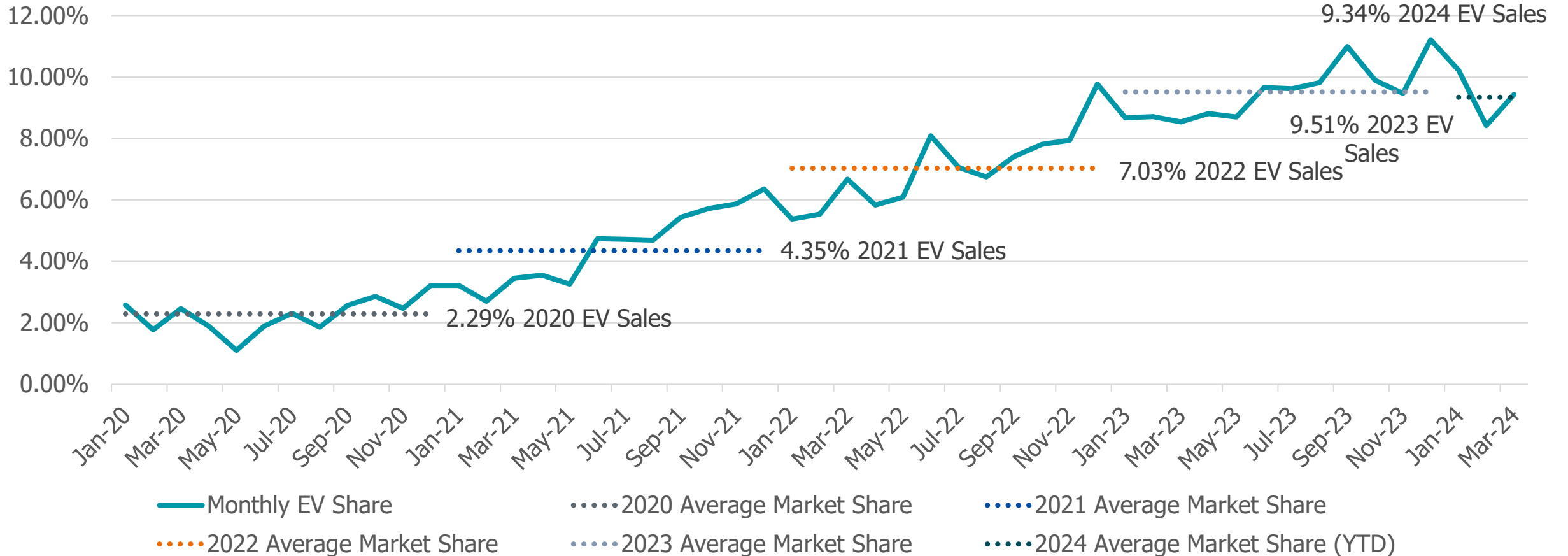

Year-over-Year Market Share Change of Powertrains

Internal combustion engine (ICE) vehicle market share decreased by 4.6 pp during Q1 2024 compared to the same period last year. Nearly all of ICE's market share was displaced by gains of traditional hybrids and plug-in hybrid vehicles, offset slightly by market share losses from BEVs and FCEVs.

Year-over-Year Change in Powertrain Market Share: Q1 2024 vs Q1 2023

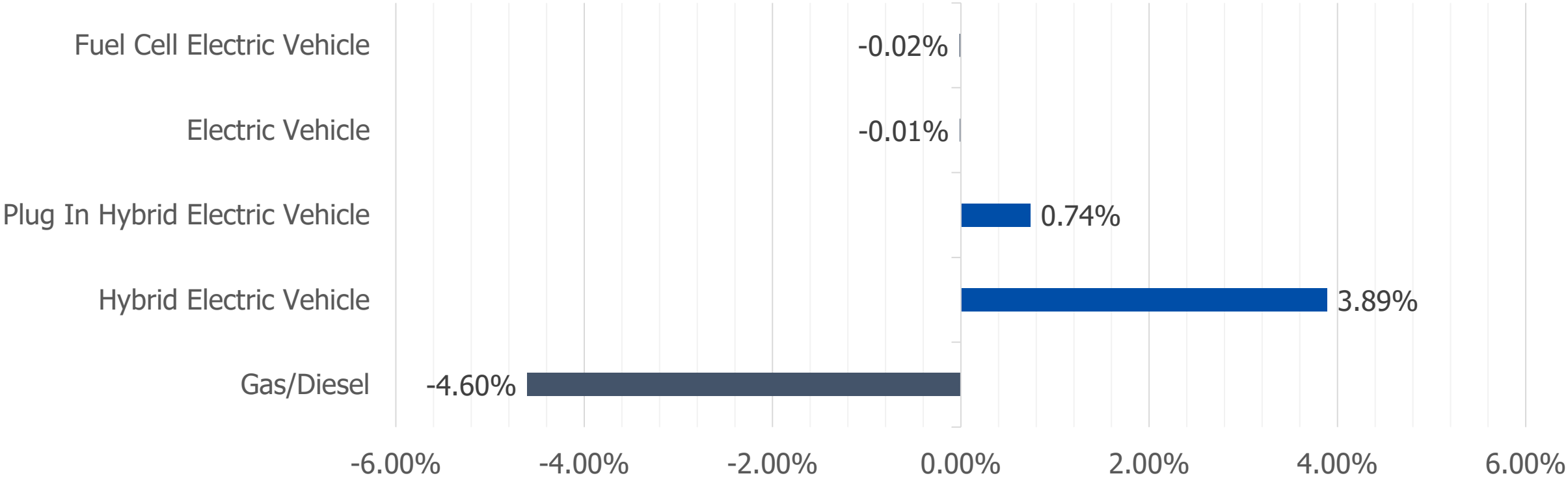

EV Sales: 2021 – 2024 (Q1)

California continued to lead the nation in EV sales, with BEVs, PHEVs and FCEVs making up 25 percent of new light-duty vehicle registrations in the first quarter of 2024. There are currently eleven additional states and the District of Columbia with new vehicle EV registrations above 10 percent.

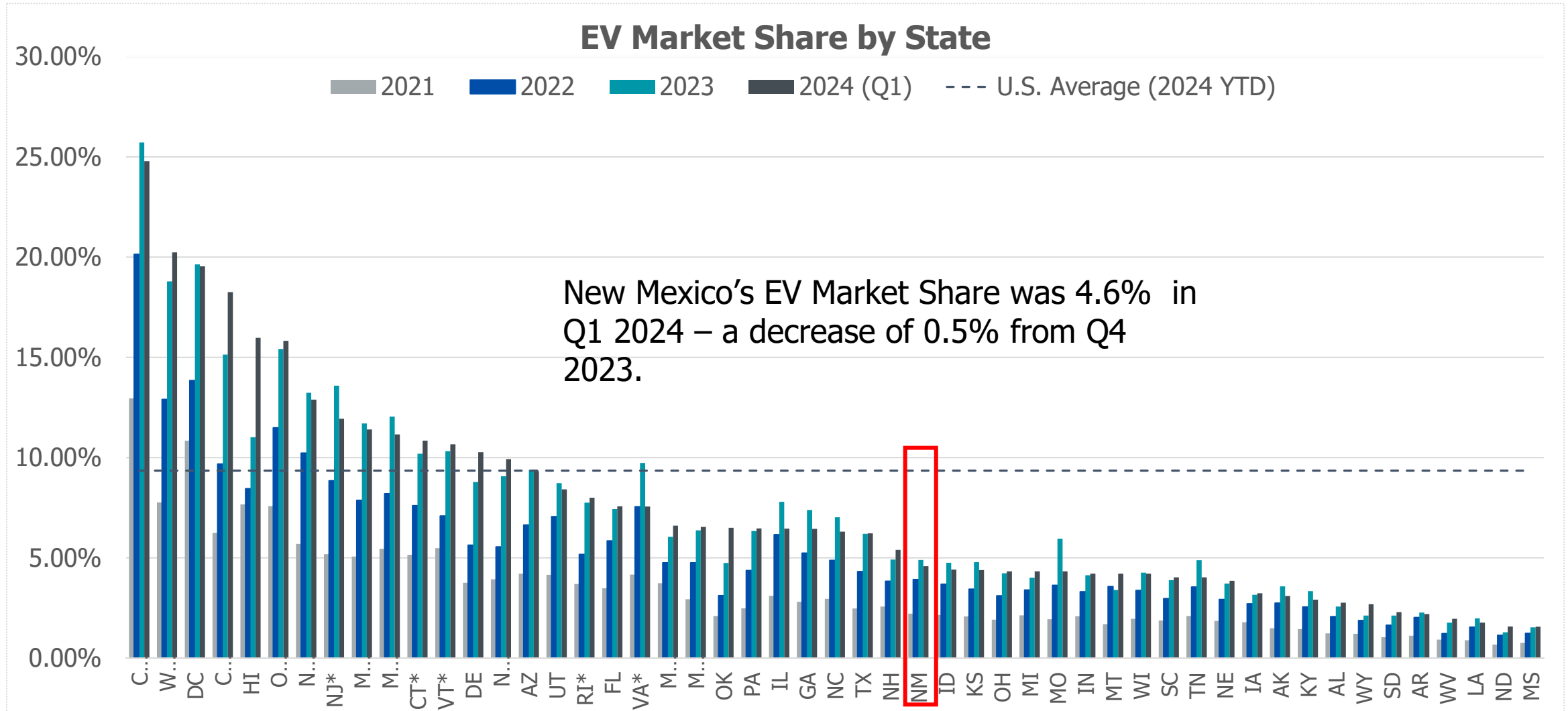

EV Industry Headwinds 2026-2030

- **Infrastructure – residential, workplace, corridor, and public – still lags**
- **Average EV prices are more than conventional vehicles**
 - Current buyers are not a cross section of buyers, but mostly affluent single-family homeowners
 - Transition to 30, 50, or 70% requires broader participation (MUDs, lower income)
- **CA regulations (durability, warranty, minimum range, data standardization, charging requirements, convenience charger, etc.) will increase prices further**
- **Demand for and prices of raw materials (Li, Ni, Co) sharply higher resulting in higher battery costs**
- **New factories required to meet increased U.S. and global requirements**



Emissions Regulatory Landscape

1 Tailpipe, 4 Agencies, 7 Regulations

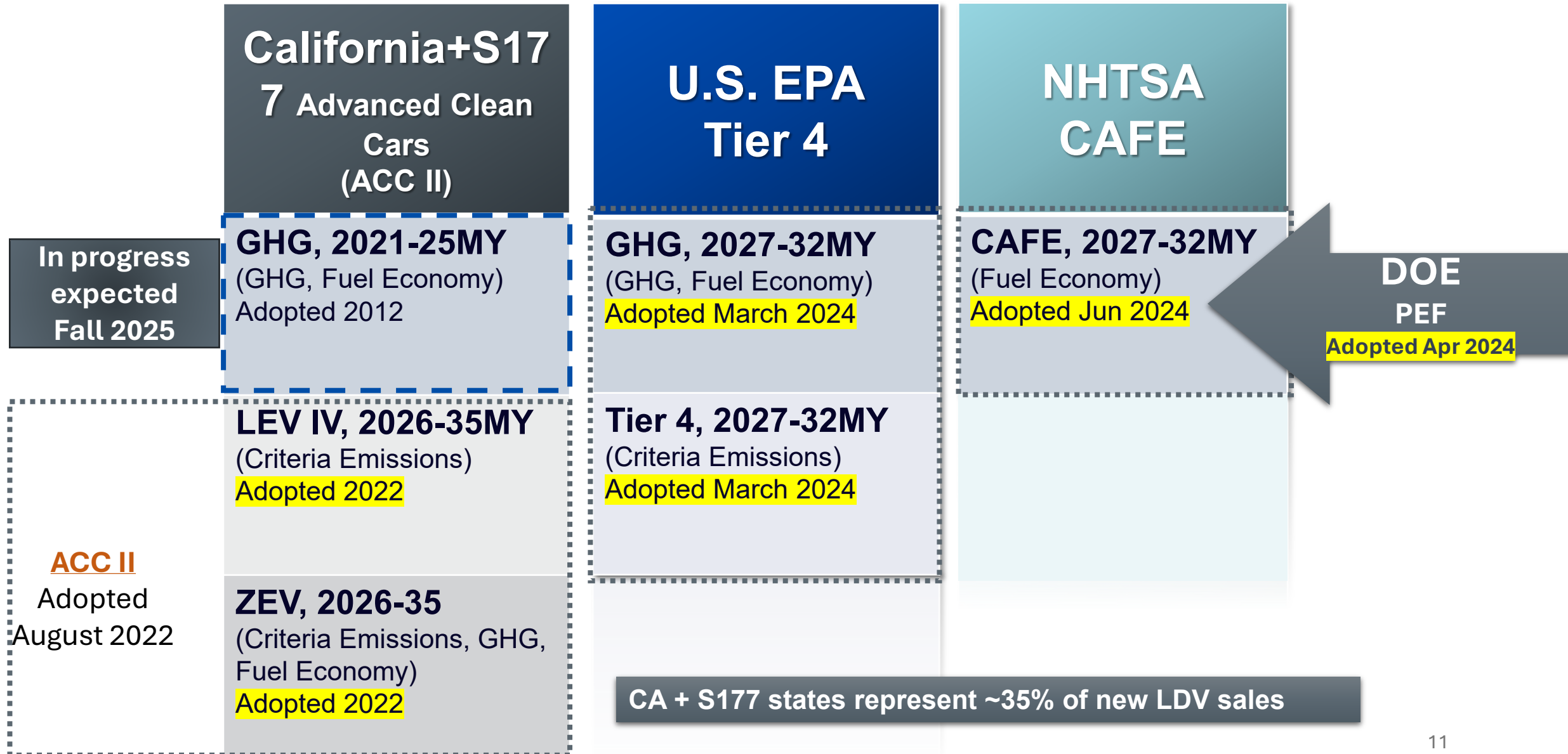

CA ZEV (BEV + PHEV) Mandate

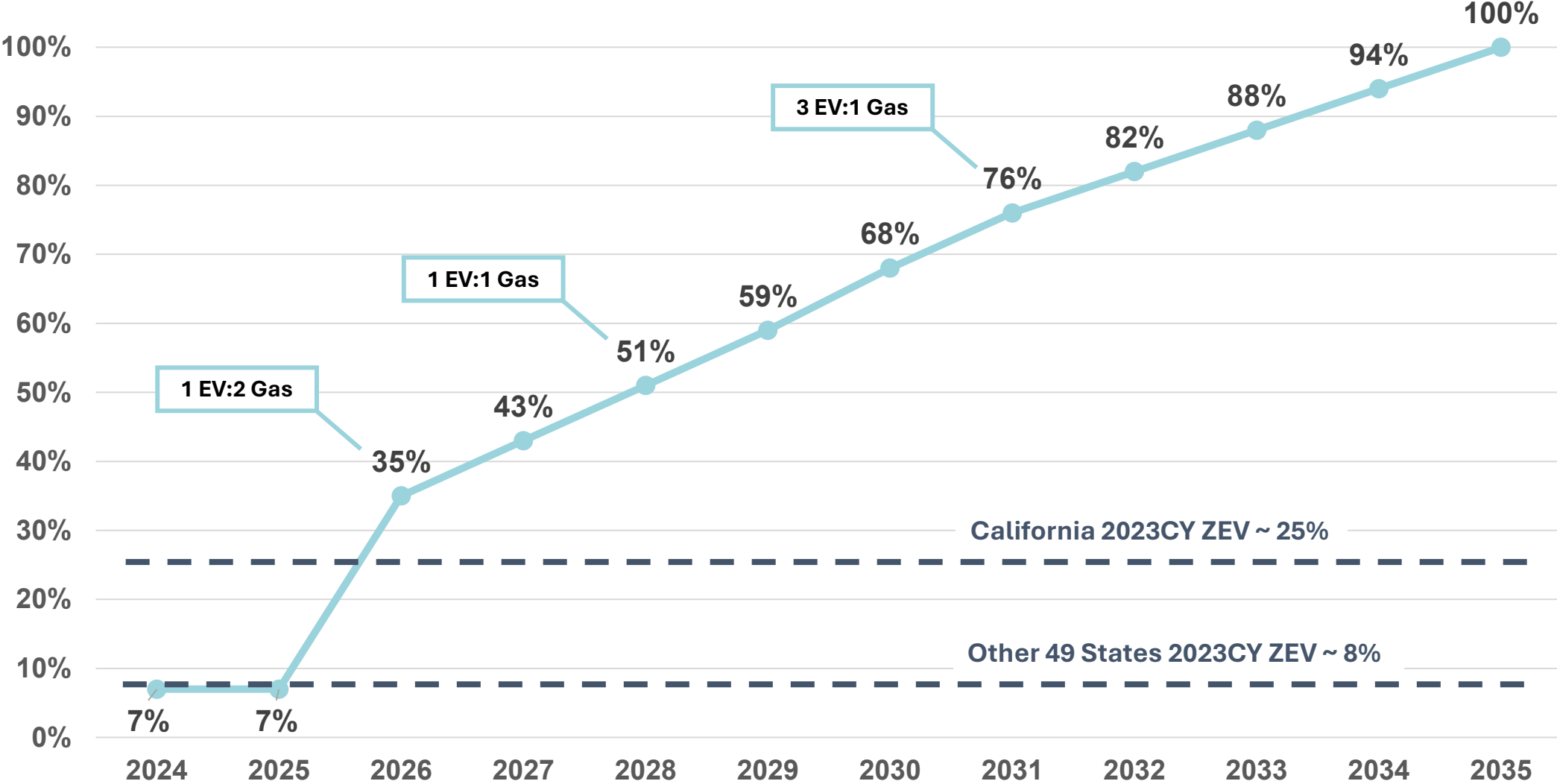

BEV and PHEV Requirements: CARB ZEV Mandate vs EPA GHG

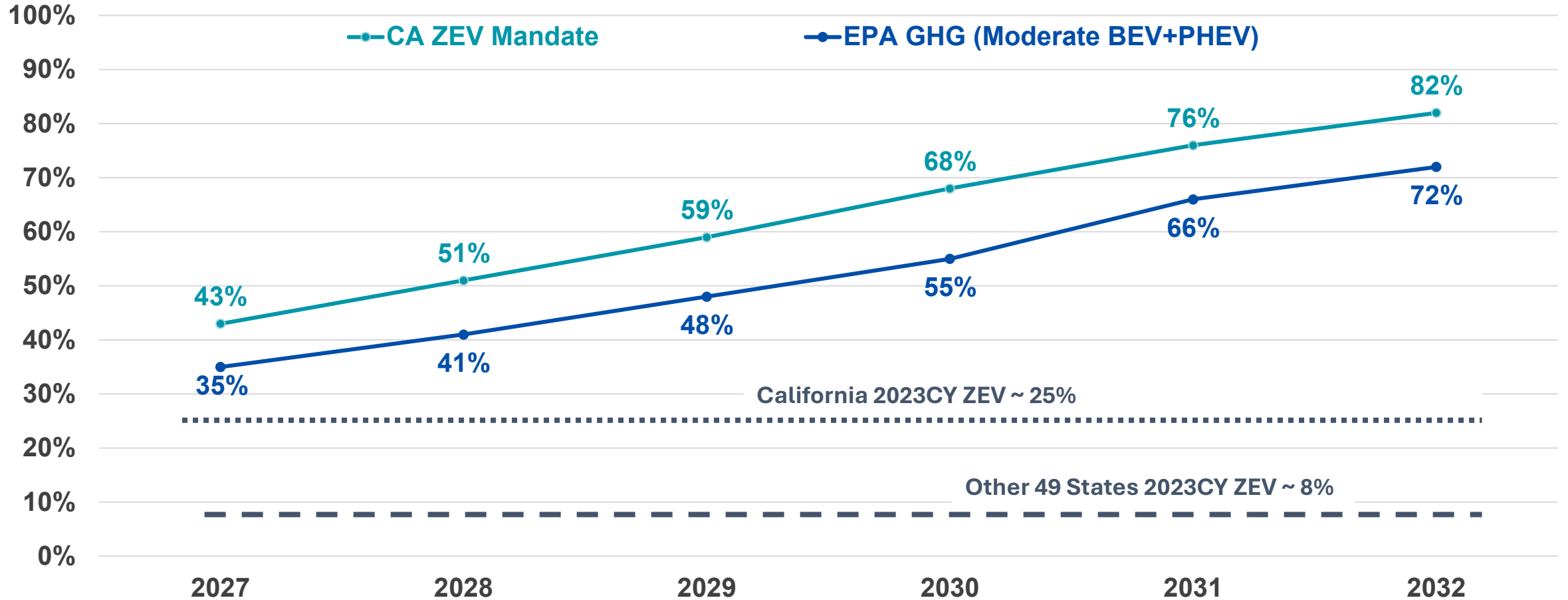

Note that EPA's GHG ZEV is roughly one year behind California's ZEV Mandate.

CA ZEV (BEV + PHEV) Mandate

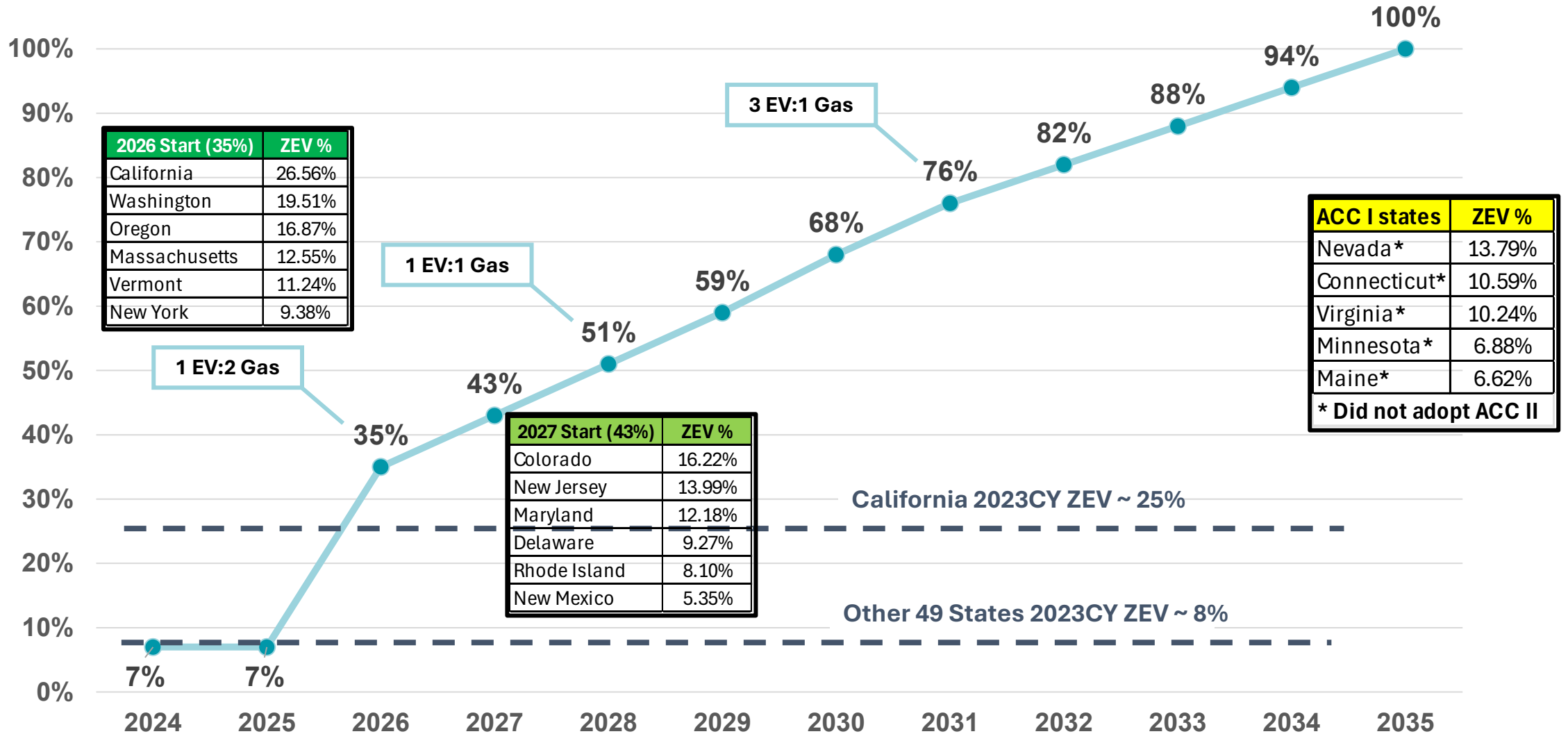

EV Sales By State vs 2026-27 ZEV Sales Mandate

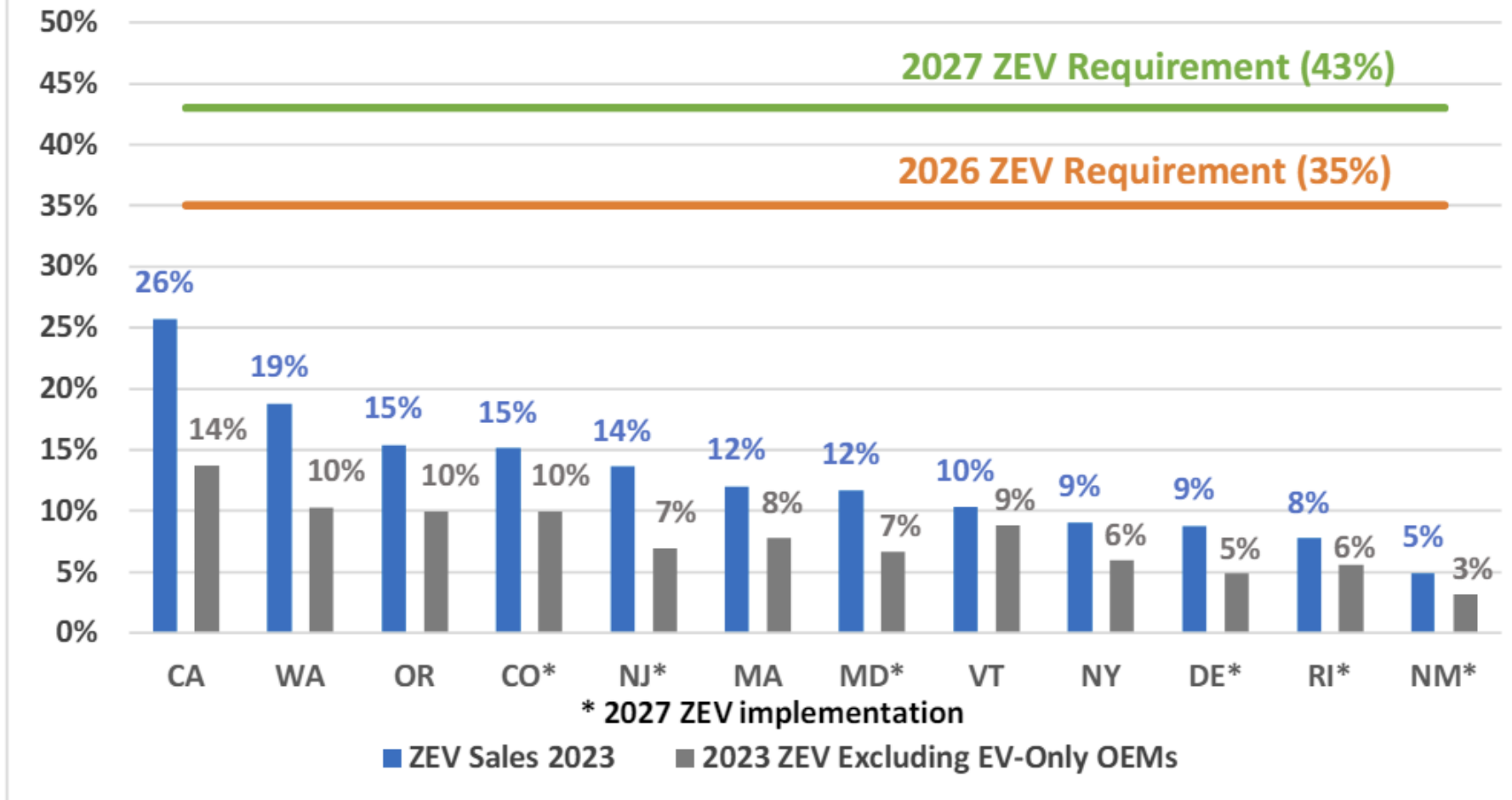

Figure 1: 2023 calendar year ZEV sales rates in California and Section 177 States compared to ACC II requirements in MYs 2026 and 2027. Note, ZEV sales requirements rapidly increase, reaching 51% in 2029, 76% in 2031, and 100% in 2035, leaving little or no room to make up deficits in a later year.



***Where Does New Mexico Stand on
the New Landscape?***

New Mexico Sales by Type: 2023

In 2023, the U.S. Average for light truck market share was 80%; the national average for pickup trucks was 18%.

NEW MEXICO SALES BY VEHICLE TYPE: 2023

■ Cars ■ UVs* ■ Pickups ■ Vans/Minivans

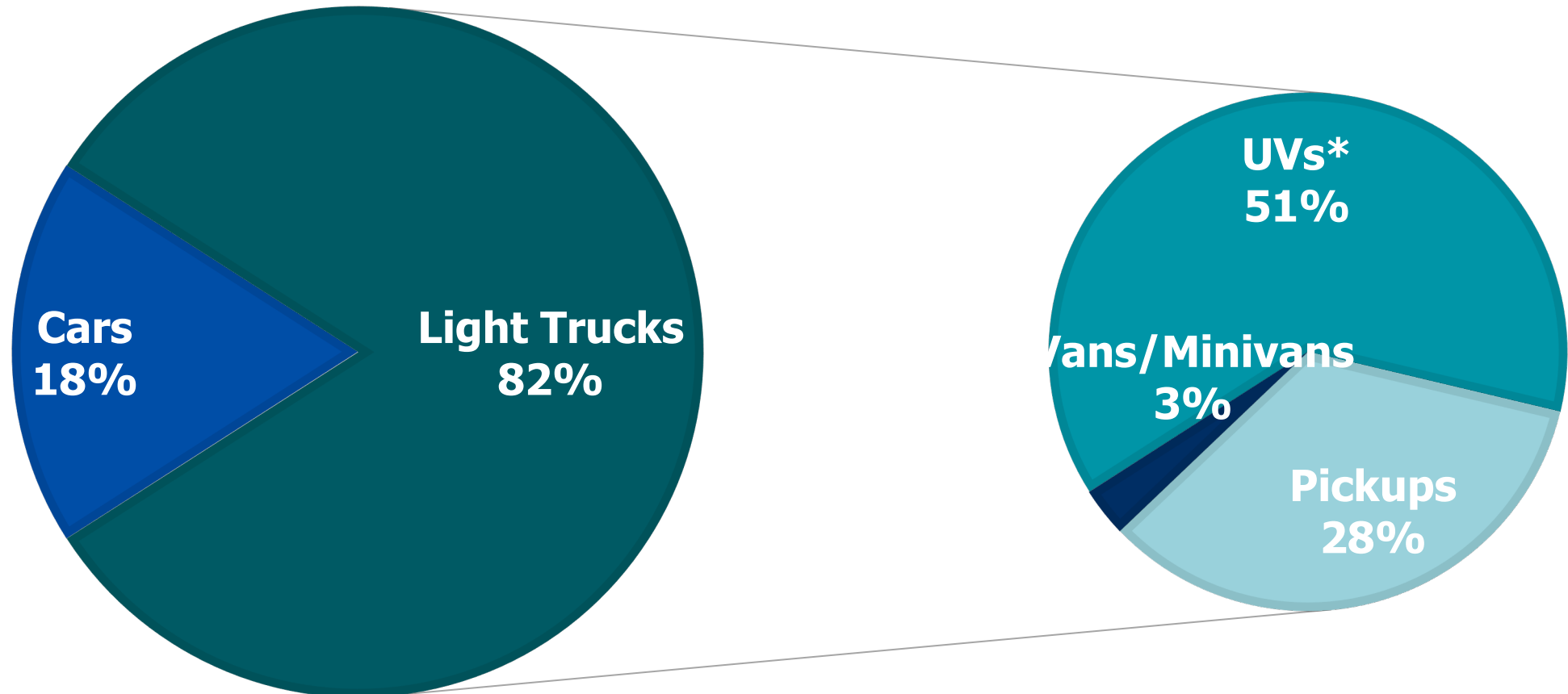

New Mexico Sales by Powertrain: 2023

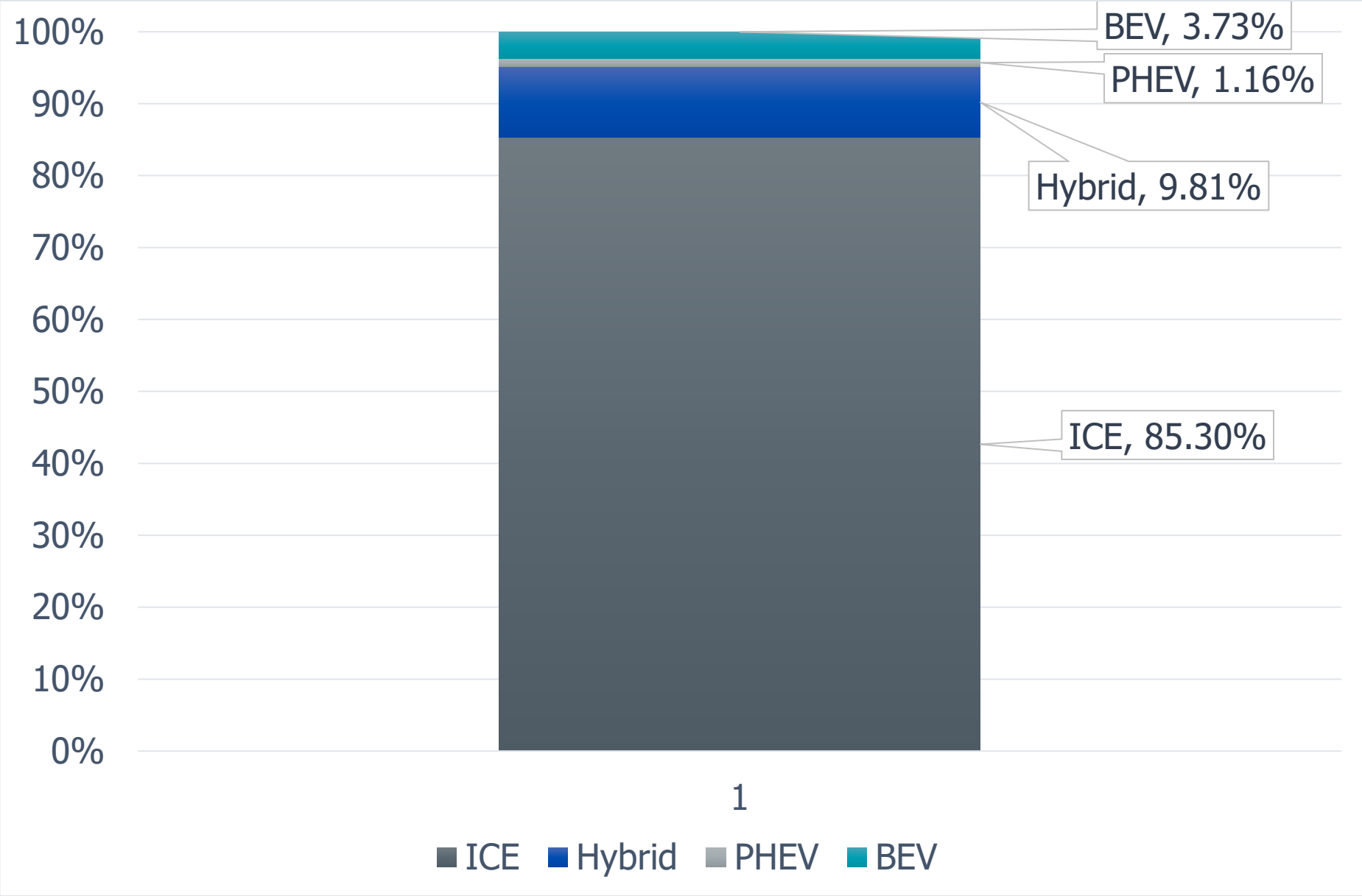

EV Sales: New Mexico

New Mexico's EV Market Share for 2023 (full year) was 4.9%, up from 3.9% in 2022. The market share for Q1 2024 was 4.6%

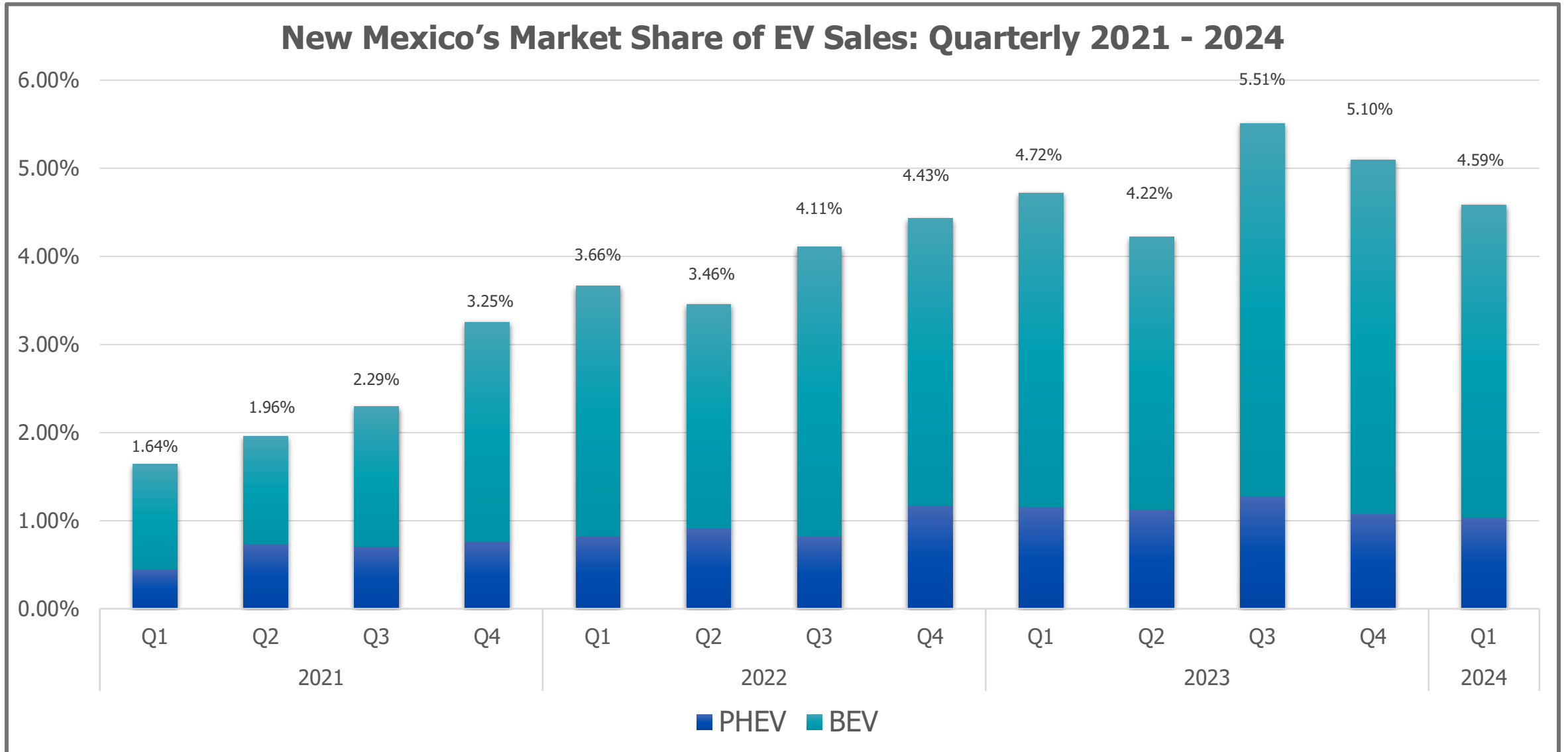

Market Share Change Q4 2023 to Q1 2024

Only eight states saw an increase in market share from the fourth quarter of 2023. Forty-two states and DC lost market share from the fourth quarter.

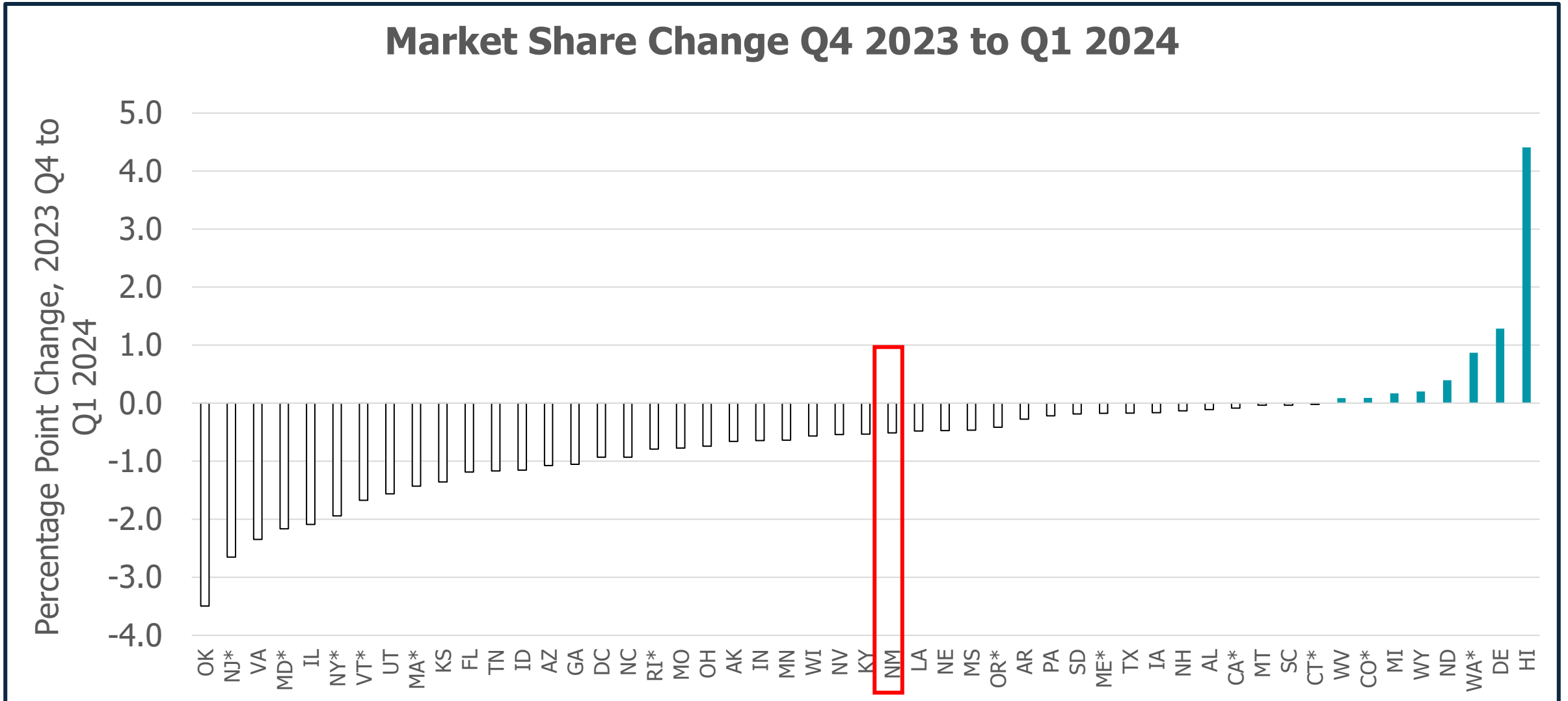

New Mexico's Electric Vehicles in Operation (through Q1 2024)

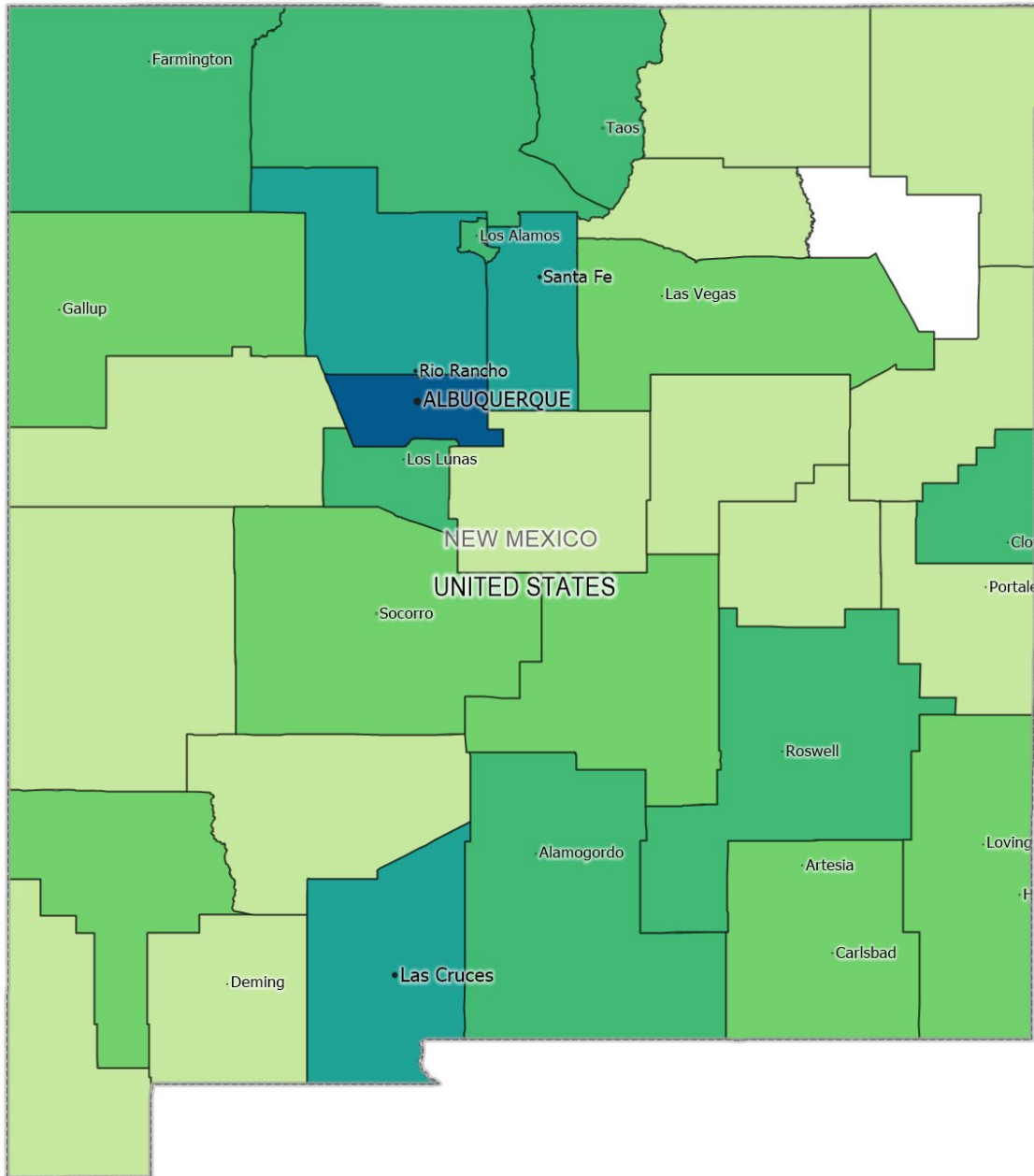

There are 2,015,998 vehicles registered in New Mexico:

- 14,783 EVs (.7% of all registered vehicles)
- All but one of New Mexico's 33 counties have at least one registered EV.

TOP TEN COUNTIES	
COUNTY	#EVS
BERNALILLO	6700
SANTA FE	2774
SANDOVAL	1541
DOÑA ANA	1181
LOS ALAMOS	390
VALENCIA	306
TAOS	270
OTERO	231
SAN JUAN	190
CURRY	169

Number of Registered EVs

- No Registered EVs
- Less than 50 Registered EVs
- Between 50 - 100 Registered EVs
- Between 100 and 500 Registered EVs
- Between 1000 and 3000 Registered EVs
- More than 5000 Registered EVs

New Mexico's Public Charging Locations

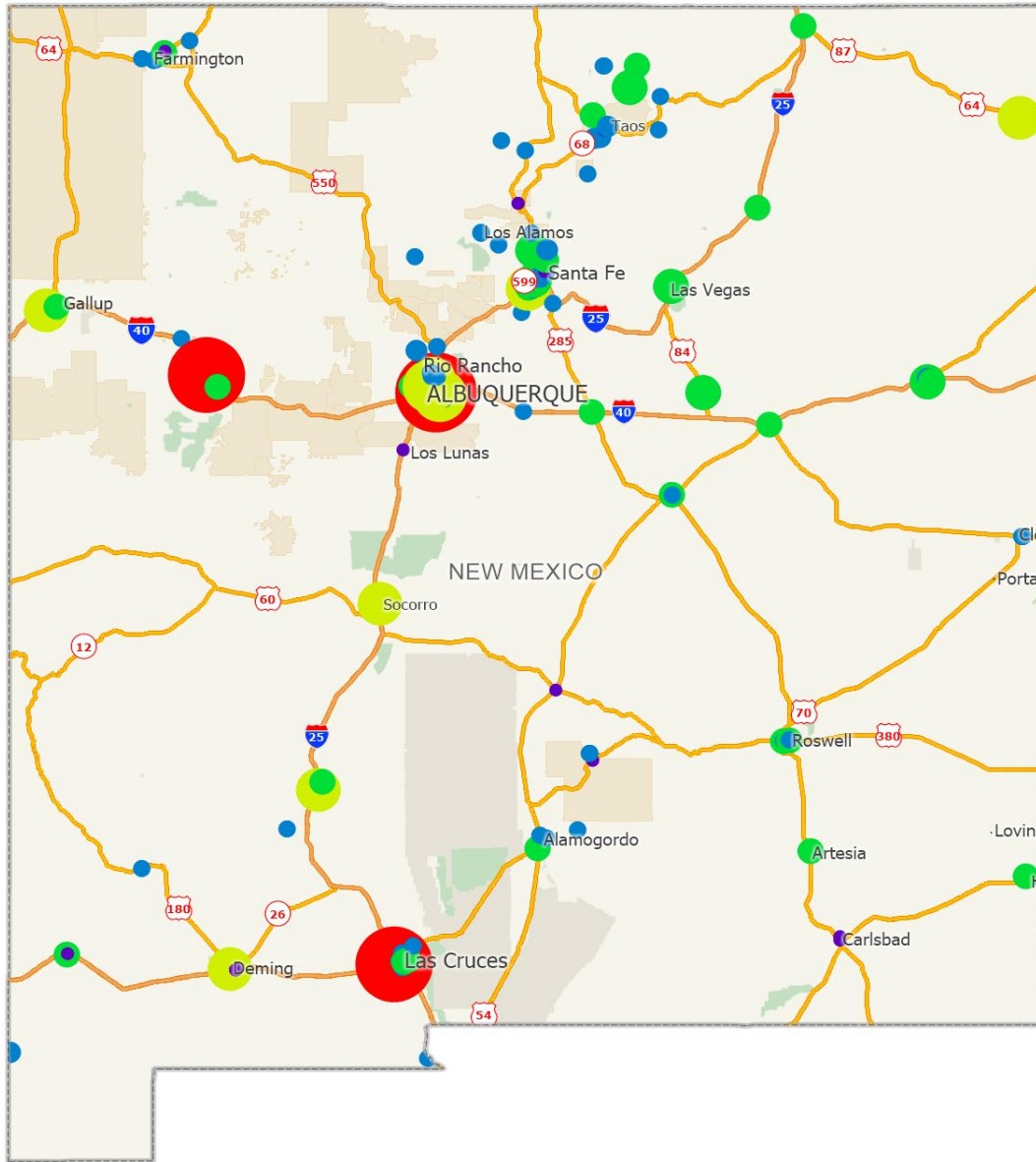

There are 297 Public Charging Locations in New Mexico:

- 694 Total Ports
- 441 Level 2 Chargers (226 Locations)
- 307 DC Fast (72 Locations)
- There are 21 ports for every registered EV (ranking 26th in the nation)
- 64 Ports were added between the end of Q4 2023 and Q1 2024 for **847 NEW EVs** sold – a ratio of 13 ports per new EV

Charging Locations

of Charging Ports

- 1
- 2 to 3
- 4 to 7
- 8 to 14
- 15 and above

Total





Necessary Conditions for Success

Keys to Expanded Electric Vehicle Adoption

- Convenient, easy to use, everywhere
- Top reason to reject an EV “Nowhere to Charge”

- Buy-in from all new vehicle purchasers

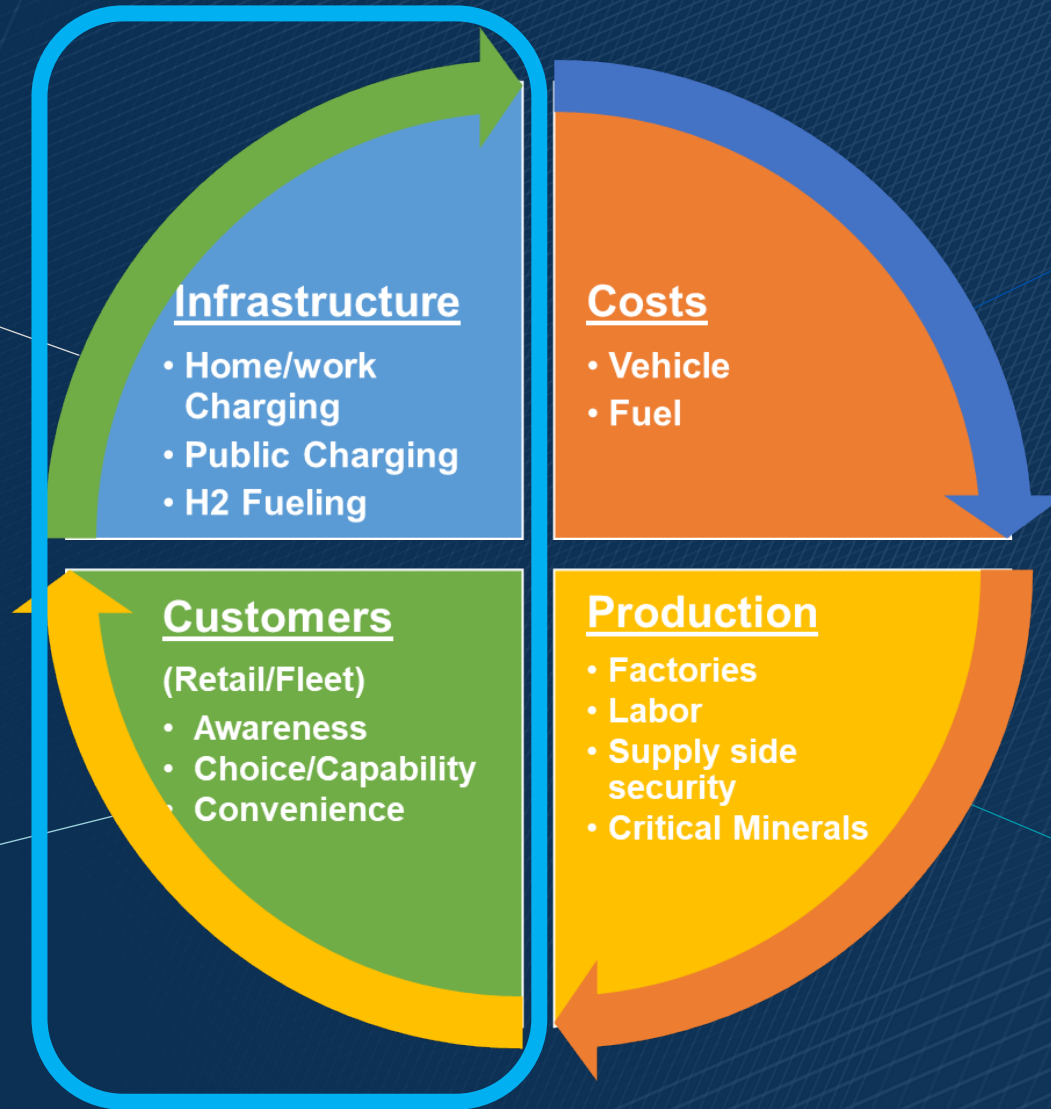

- EVs still more expensive than gas - Incentives help bridge the gap
- Fuel must be cheaper than gas

- Automakers investing \$515 billion domestically by 2030 (starting line)
- Building a new global supply chain from scratch, hundreds of factories.

Market Questions

Auto Makers Can Build Them

- Over 114 EV models available
- BEV, PHEV, FCV
- Praised by reviewers and customers

Reaching EV Goals Requires Answering These Questions

1. Can people afford them? Vehicle and fuel cost
2. Can people fuel them? 50% of Americans do not have dedicated off-street parking
3. Can automakers develop the supply chain necessary to support the necessary production?
4. Will buyers (new and used) embrace them? Range anxiety, cost, and politicization issues

Transaction Prices: 2021 – 2024 (Q1)

The average transaction price for a new EV in Q1 was \$55,167, a 9.0 percent decrease compared to Q1 2023 and down 3.8 percent quarter over quarter.”¹ While increased competition in the EV market has led to some price decreases, slowing sales paired with increased inventory and incentives are also playing a part in lower transaction prices.

Transaction Prices: Quarterly Averages

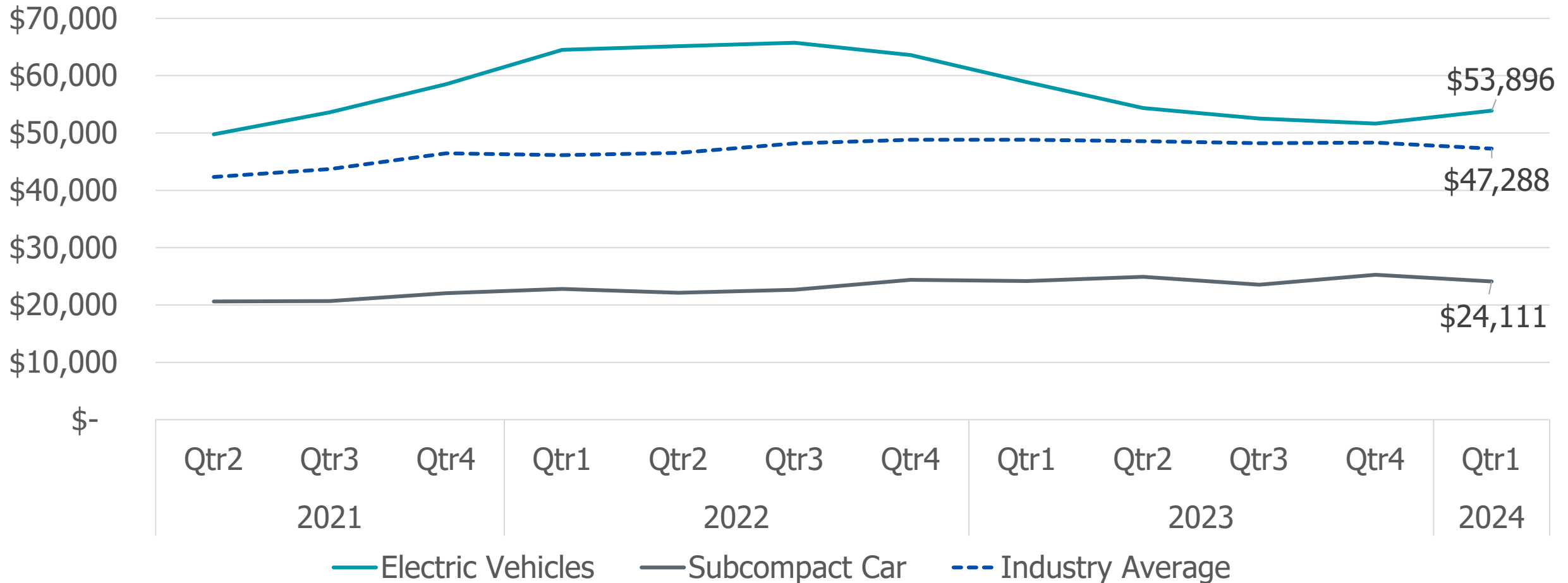

EV MSRPs higher than gas models

- 60% of gas vehicle registrations are under \$40,000
- 10% of electric vehicle registrations are under \$40,000

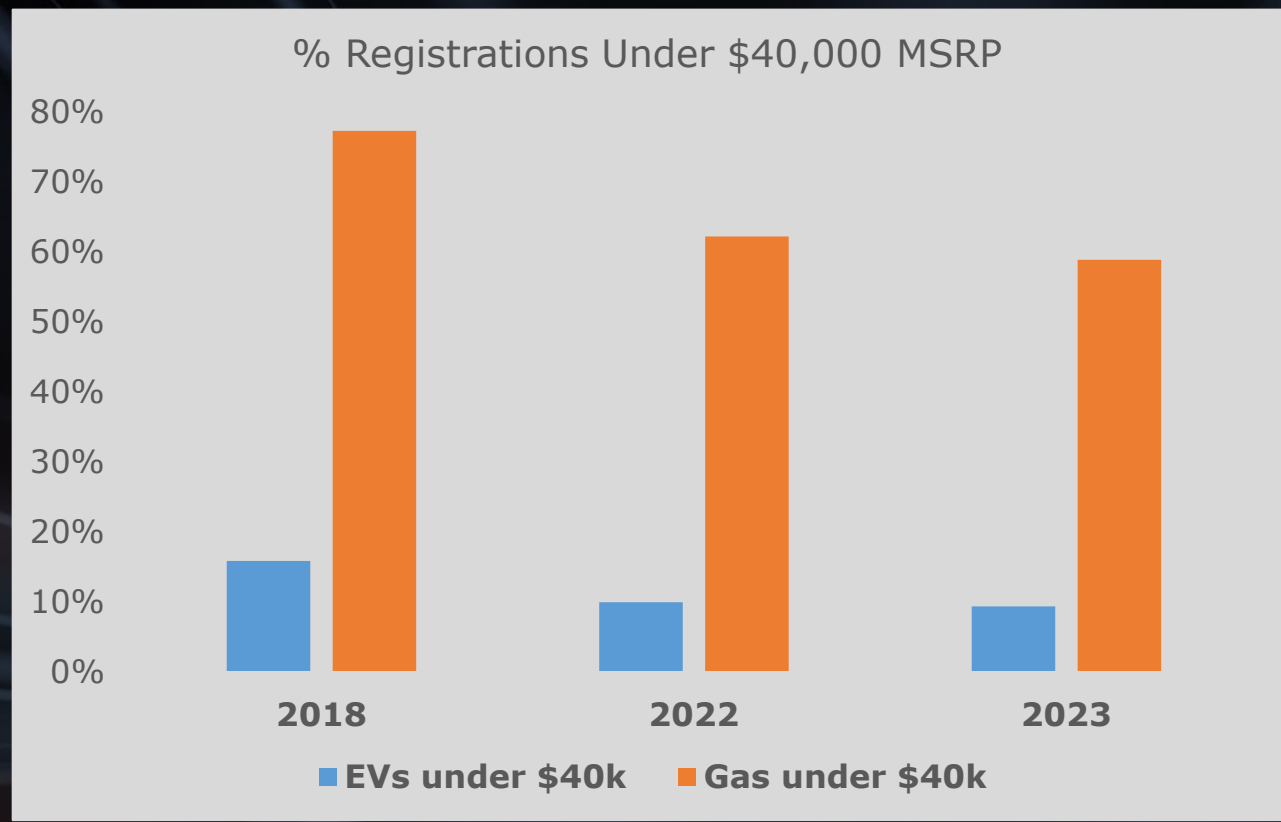

EV cost structure must improve before prices will fall

U.S. EV Retail Market Disposition

EVs are on the rise—but have yet to go mainstream

EV SHARE OF U.S. RETAIL MARKET



8.0%

EV MARKET SHARE (1H 2023)

582K

TOTAL EV SALES

460K

EV PREMIUM
(79% OF TOTAL)

366K

TESLA
(80% OF PREMIUM)

122K

EV MAINSTREAM
(21% OF TOTAL)

KEY POINT

The EV market's 79% premium/21% mainstream split is **nearly the exact opposite** of the auto market overall (19% premium/ 81% mainstream)

Source: J.D. Power U.S. Market New Energy Vehicle Update

J.D. POWER



EV Charging Infrastructure

Energy Grid and EV Charging Infrastructure

Energy Grid

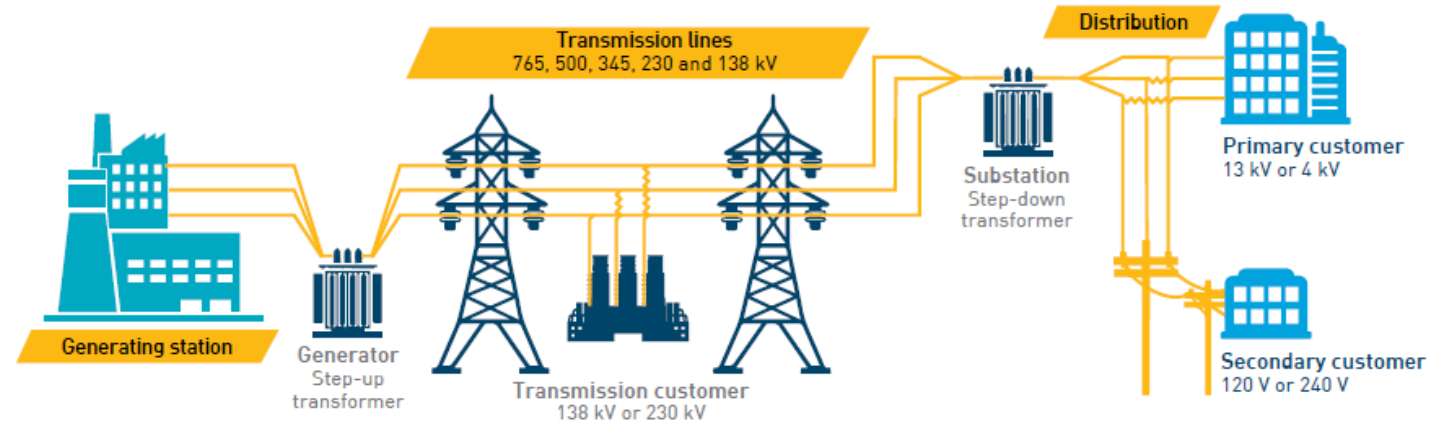

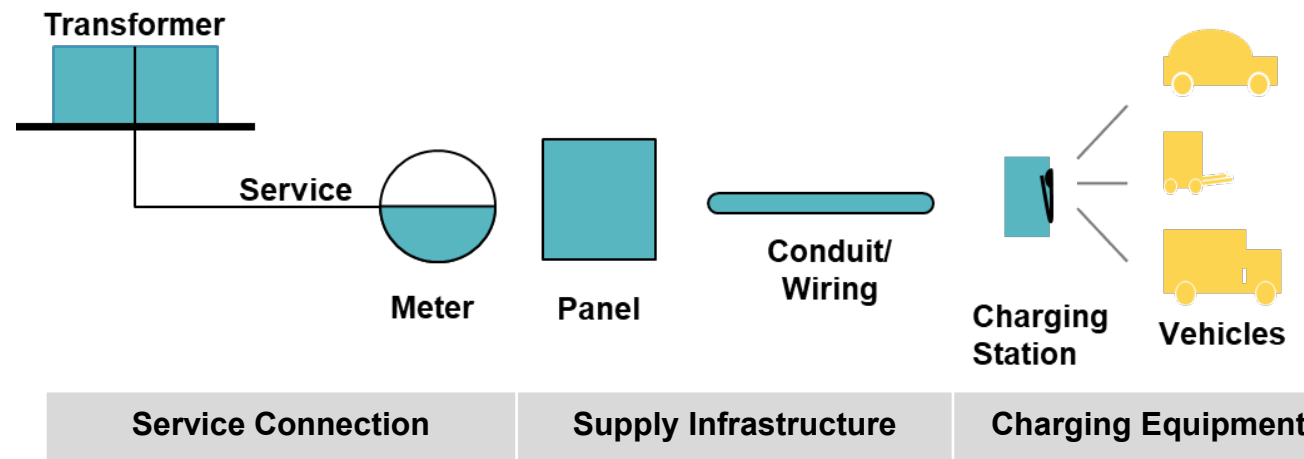

Charging Infrastructure

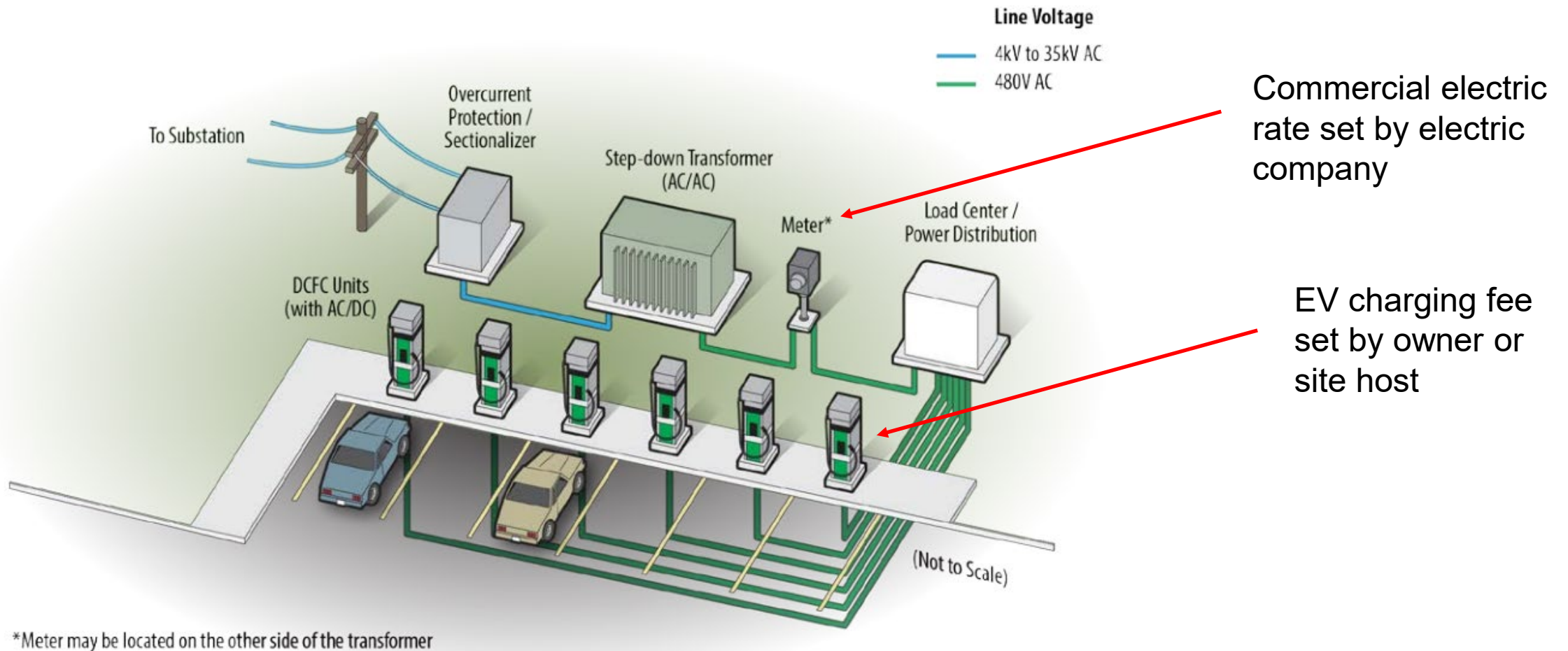

EV Charging Infrastructure

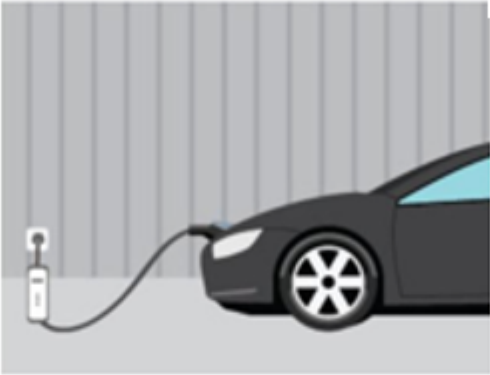

Leveling Up – EV Charging Basics

		Range	Application
Level 1		3 to 6 Miles of range/hour	<ul style="list-style-type: none">• Residential PHEV• Airports• Some workplace
Level 2		20 to 40 Miles of range/hour	<ul style="list-style-type: none">• Residential• Workplace• Public• Fleet (overnight)
Level 3 (Direct Current Fast Charge, DCFC)		250 to 500 Miles of range/hour	<ul style="list-style-type: none">• Corridor (IIJA)• Transit hub (TNC, Taxi)• City Center Cluster• Fleet

Infrastructure – Types of EV Chargers

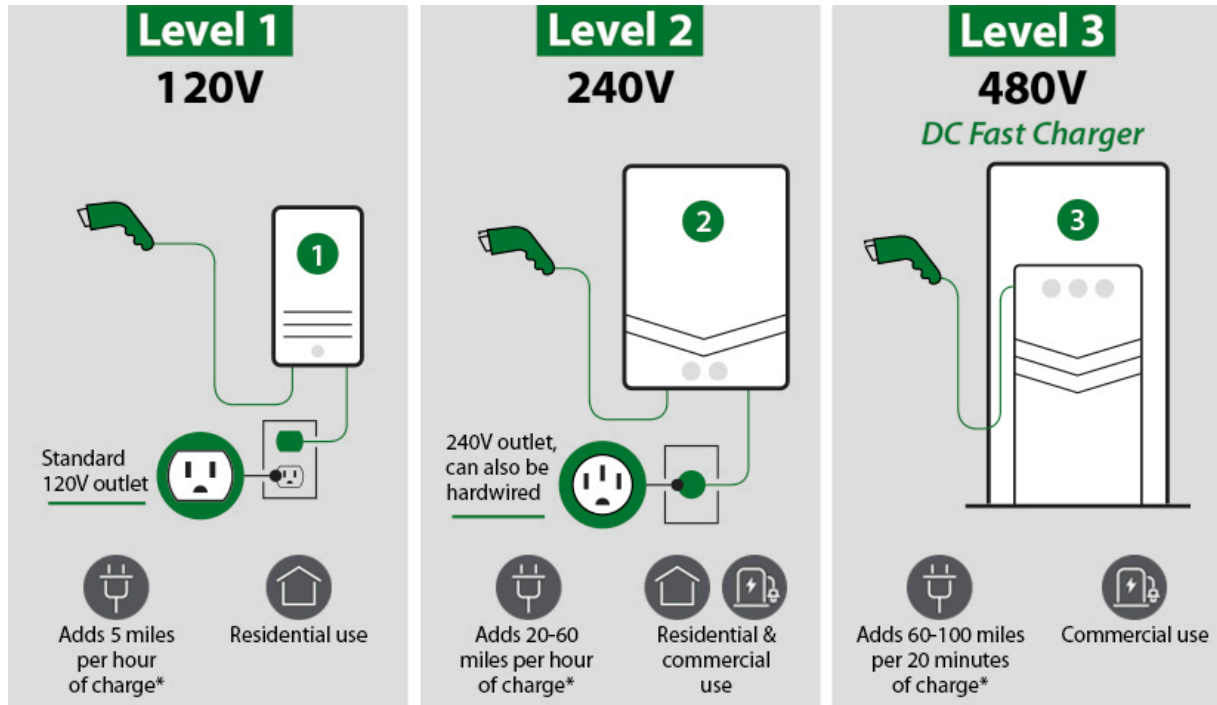

* Estimated. Actual charge times may vary.

- When we talk about infrastructure, we're talking about Level 2 and Level 3 (DC Fast) chargers
- Level 2 chargers are appropriate for Home and work, where the vast majority of charging will take place
- Level 3 chargers are necessary for those taking longer road trips, or who don't have constant access to home and work charging options

EV-Ready Parking is Categorized in Three Ways



EVSE-Capable

- Sufficient panel capacity installed and available to support future charging.
- Dedicated circuit and raceway from panel to parking stalls.



EVSE-Ready

- EVSE-Capable, plus:
- Wiring installed from panel to parking stall, terminating in a 240V outlet or junction box.



EVSE-Installed

- EVSE-Ready, plus:
- Level 2 charger installed.

Level 2 Charger

- About 80% of charging is done at home / work by level two chargers.
 - Powered by a 240W outlet
- We will soon look at Level 2 EV Chargers as a necessity, the same way we look at broadband internet access.
- Automakers support policies that will encourage public and private investment in Level 2 EV infrastructure.
 - Government buildings
 - Building codes
 - Eliminating HOA authority to place restrictions on chargers
- Critically important for both single family homes and multi-unit dwellings.



Level 3 Charging

- **Even though it represents a small percentage of miles traveled, customers are concerned about longer road trips.**
 - Cars represent freedom and mobility.
- DC chargers provide maximum efficiency in 20 – 30 minute charges.
- This is a fundamental difference from the 3-5 minute “fill up” customers are **used to**.
- As such, chargers need to be strategically located (in urban **centers and** along major travel corridors); with or near:
 - Restrooms
 - Food service
 - Retail operations; and
 - Additional amenities
- **As EVs become more prevalent, the need to reserve charging time will become critical.**



EV Charging Infrastructure Growth (2015 – 2023)

DC Fast-Chargers (July 2015)

204
stations



DC Fast-Chargers (August 2023)

8,074
Stations
33,851
Charging Ports

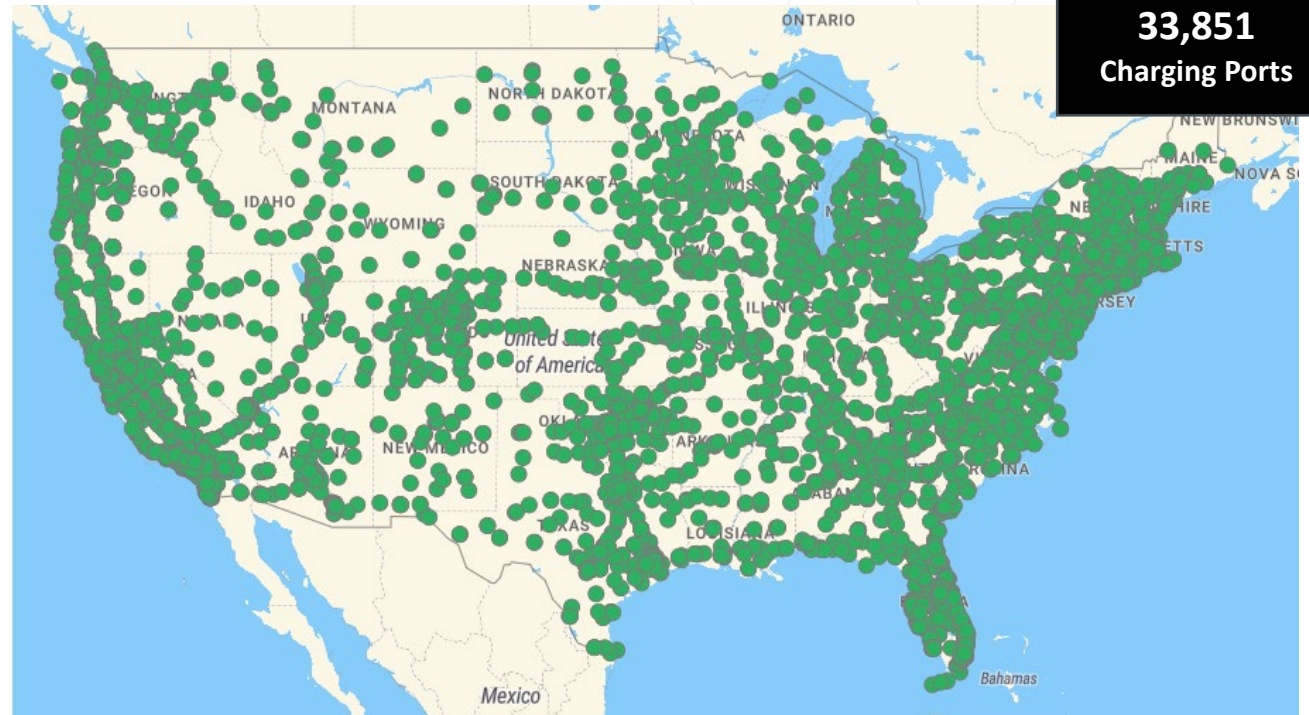

DC Fast Charging infrastructure has grown dramatically over the past several years but we still have a long way to go

Infrastructure is lacking...

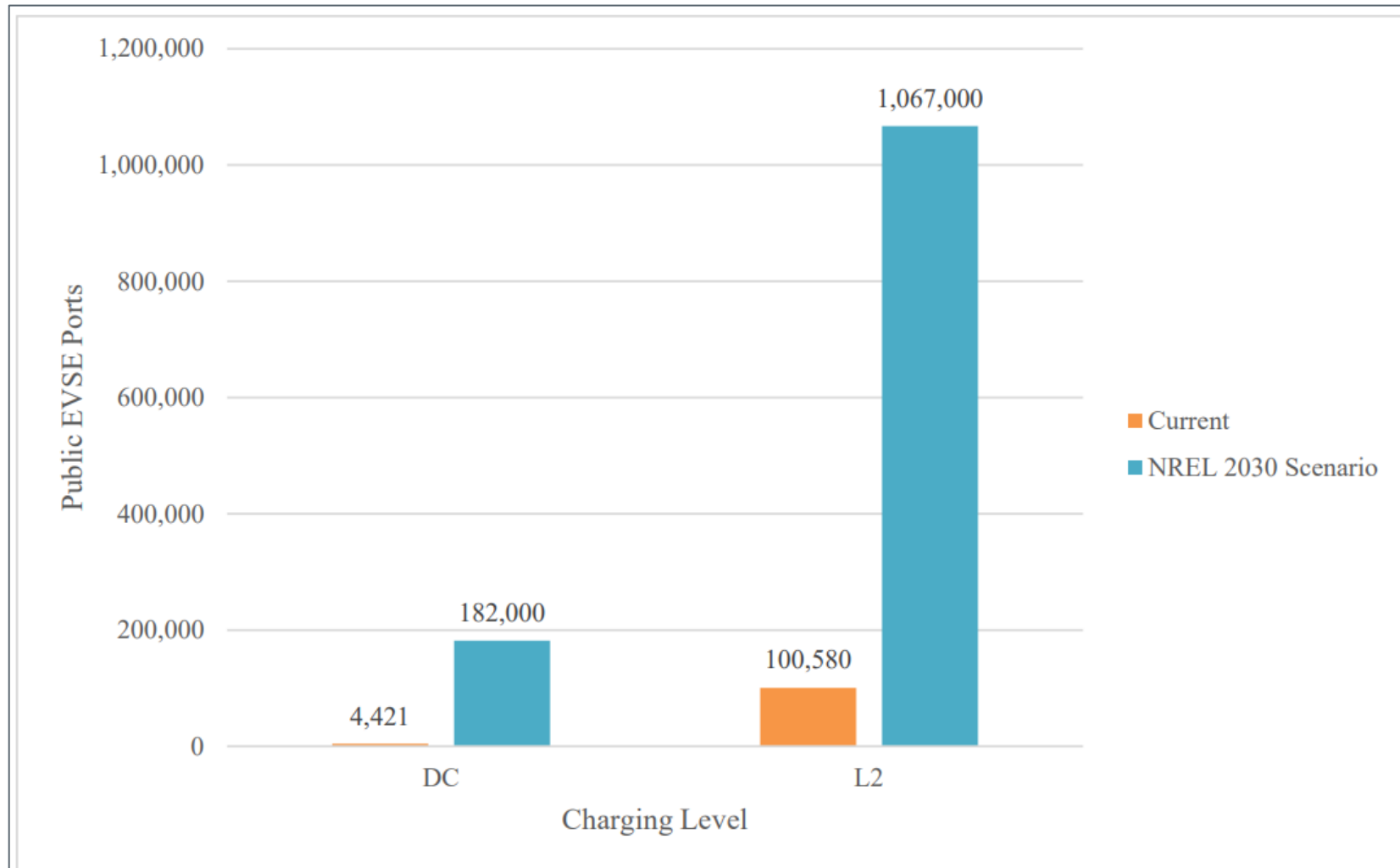
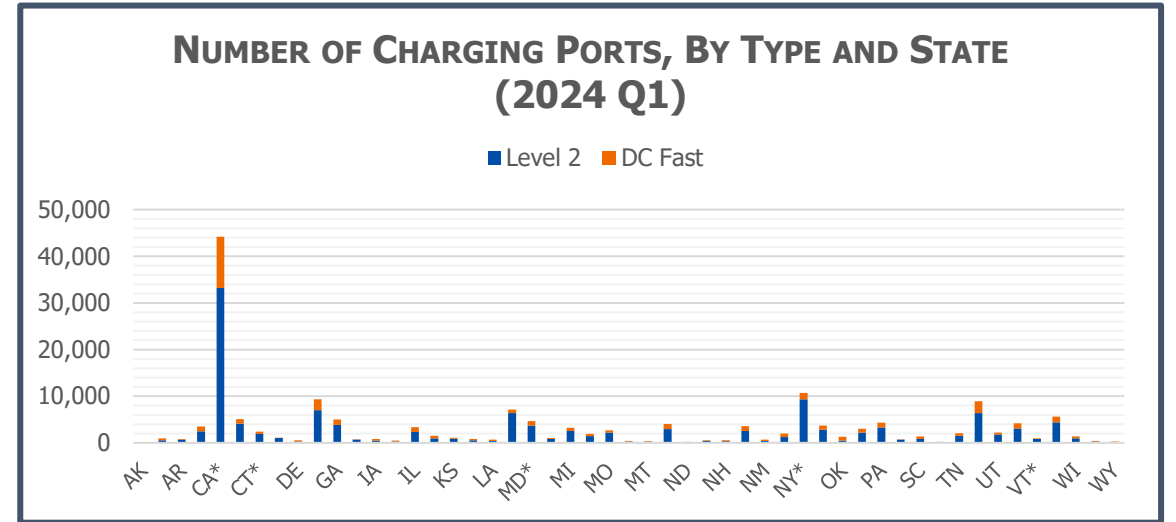
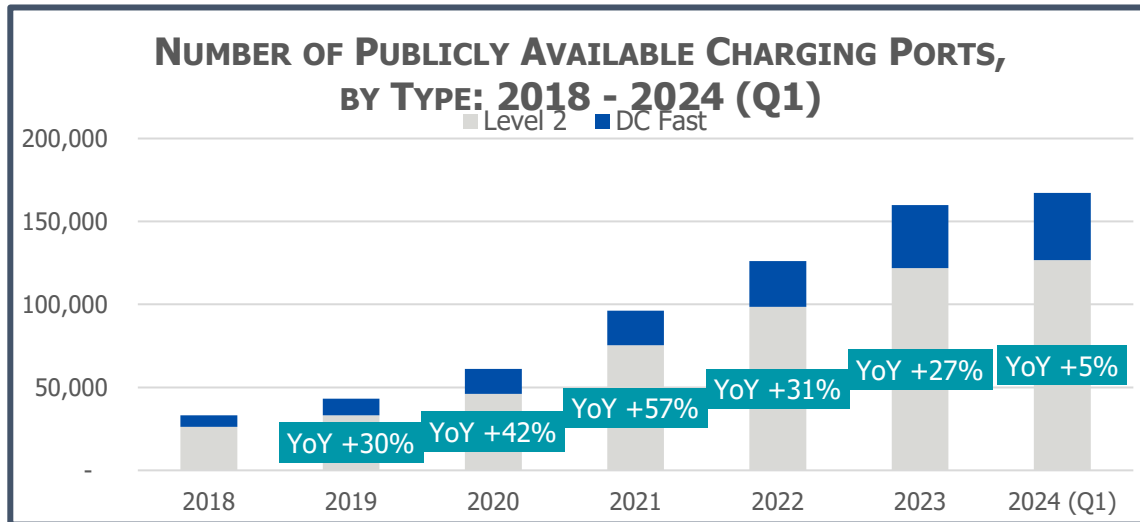

Figure 2. Current availability of public charging (excluding Tesla-only) versus NREL's scenario of 2030 public infrastructure requirements in the United States *2022 Data

Public Charging Infrastructure (through Q1 2024)

Level 2: 54,332 Locations, 126,630 EVSE Ports
DC Fast: 9,619 Locations, 40,583 EVSE Ports
Hydrogen Refueling: 56 Stations (55 are in California)
U.S. Total: 62,760 Locations, 167,213 EVSE Ports



Public Charging Infrastructure (through Q1 2024)

- U.S. National Renewable Energy Laboratory (NREL) estimated a network of **28 million charging ports** would be necessary to support **50 percent EV sales by 2030** (and 33 million EVs on the road).
- **167,000 public charging ports** across the country and **4.7 million EVs** on the road.
- Total installed public charging ports are about **13 percent** of the needed estimate to support EV penetration by 2030.
- More than **1 million additional public chargers** (940,370 L2 and 141,417 DC Fast) will need to be installed to satisfy infrastructure estimate.

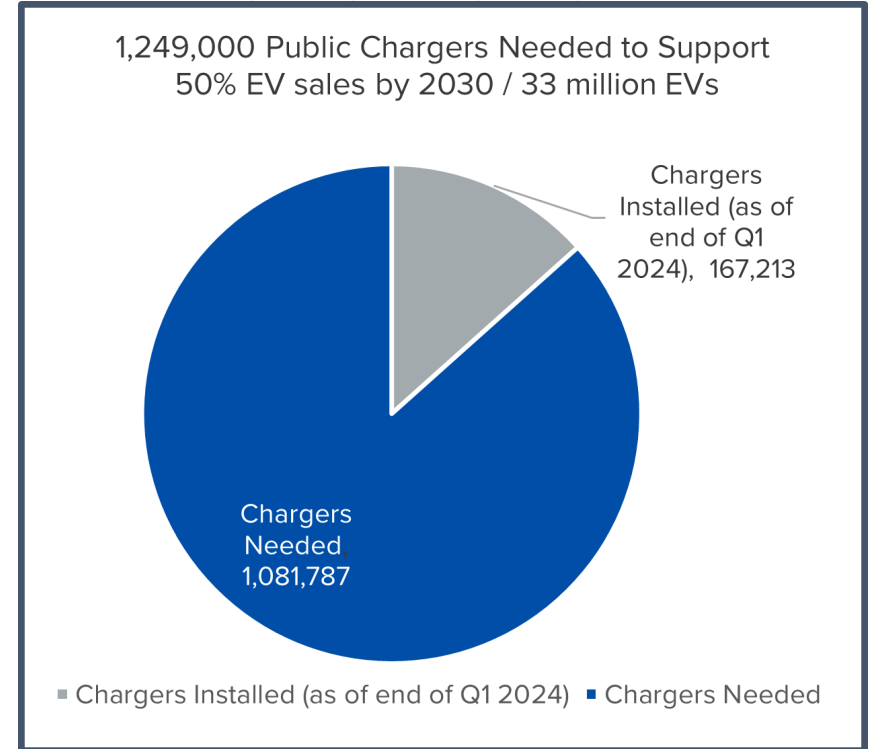

*Between the end of Q1 2024 and December 31, 2030, **438 chargers need to be installed every day, for the next 6.75 years. Or 3 chargers every 10 minutes through the end of 2030.***

New Mexico EV Charger Data

- **To meet the needs of the 2030 ZEV Mandate numbers, New Mexico would need a total of 26,914 charging stations:**
 - Level 2 Chargers
 - 8,349 at apartments and condos
 - 7,682 at private workplace parking
 - 3,788 at public workplace parking
 - 6,055 at other public locations (libraries, supermarkets, etc.)
 - DC Fast Chargers
 - 1040 in public locations
- **Today, New Mexico has 441 public L2 chargers and 307 DCFC for a total of 748 chargers.**

Based on the California Energy Commission Charging Infrastructure Assessment Model & New Mexico demographics data

EV Infrastructure – Policy Recommendations



Fast charging along highway corridors and transit hubs



24/7 access

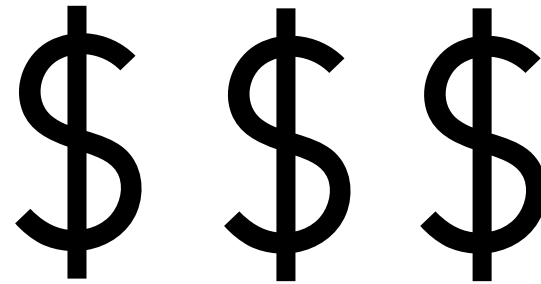

Incentives

Gasoline	Self Serve
Regular	409 ⁹ / ₁₀
Plus	417 ⁹ / ₁₀
Supreme	425 ⁹ / ₁₀
Diesel No. 2	519 ⁹ / ₁₀

Standard pricing



Uptime requirements



Accessible payment options

Final Thoughts

- **Lack of infrastructure is the number one challenge holding back EV sales**
- **We need policies that will support the expansion of Level 2 and Level 3 chargers**
- **Industry and Government both have a role to play in ensuring that our national EV charging network is reliable and accessible to customers across the country**



Additional Challenges

The Global Competition to Electrify Everything

Test for Electrification: Does It Move? Or even if it doesn't...

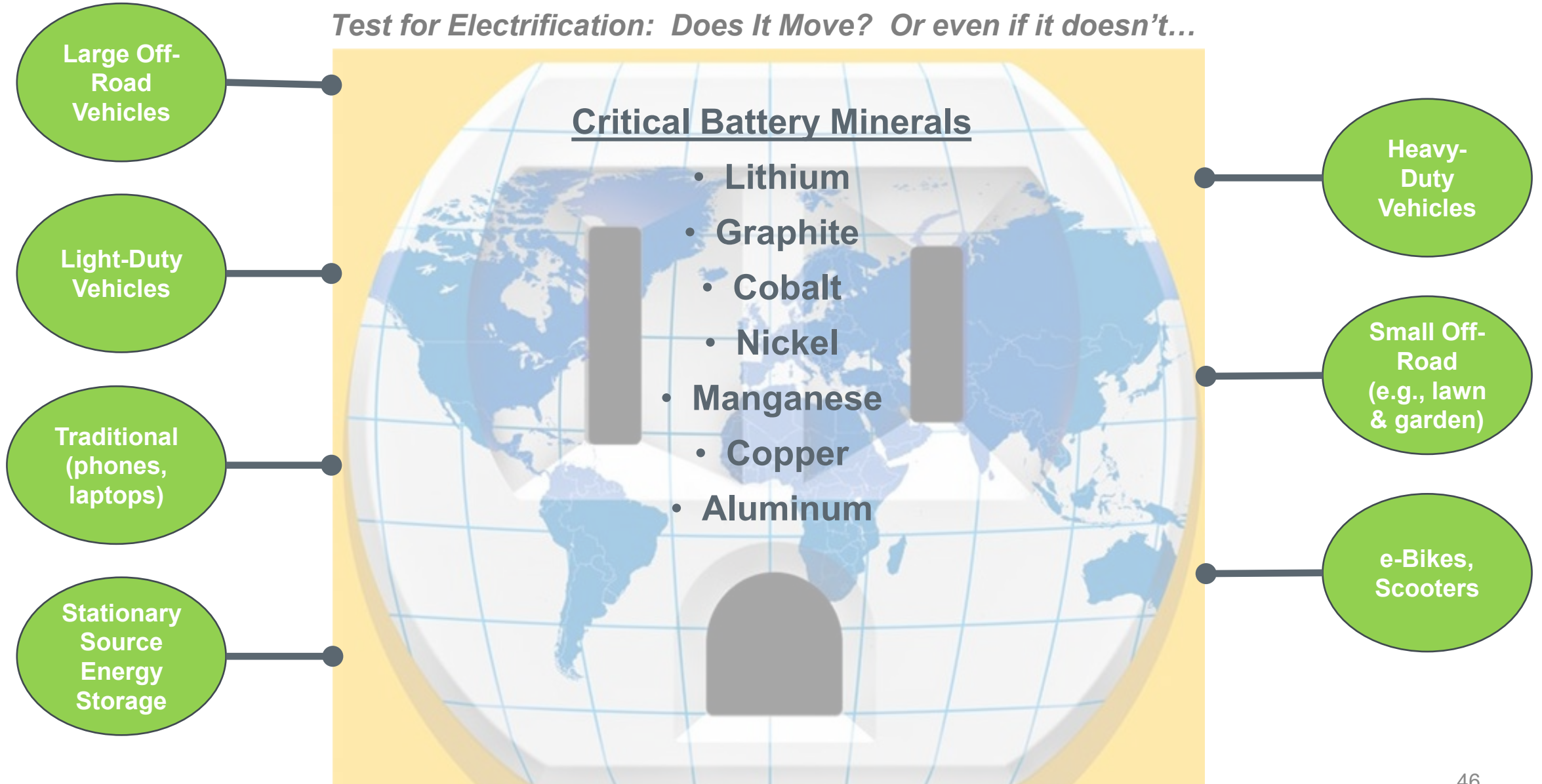

Supply Chain Challenges

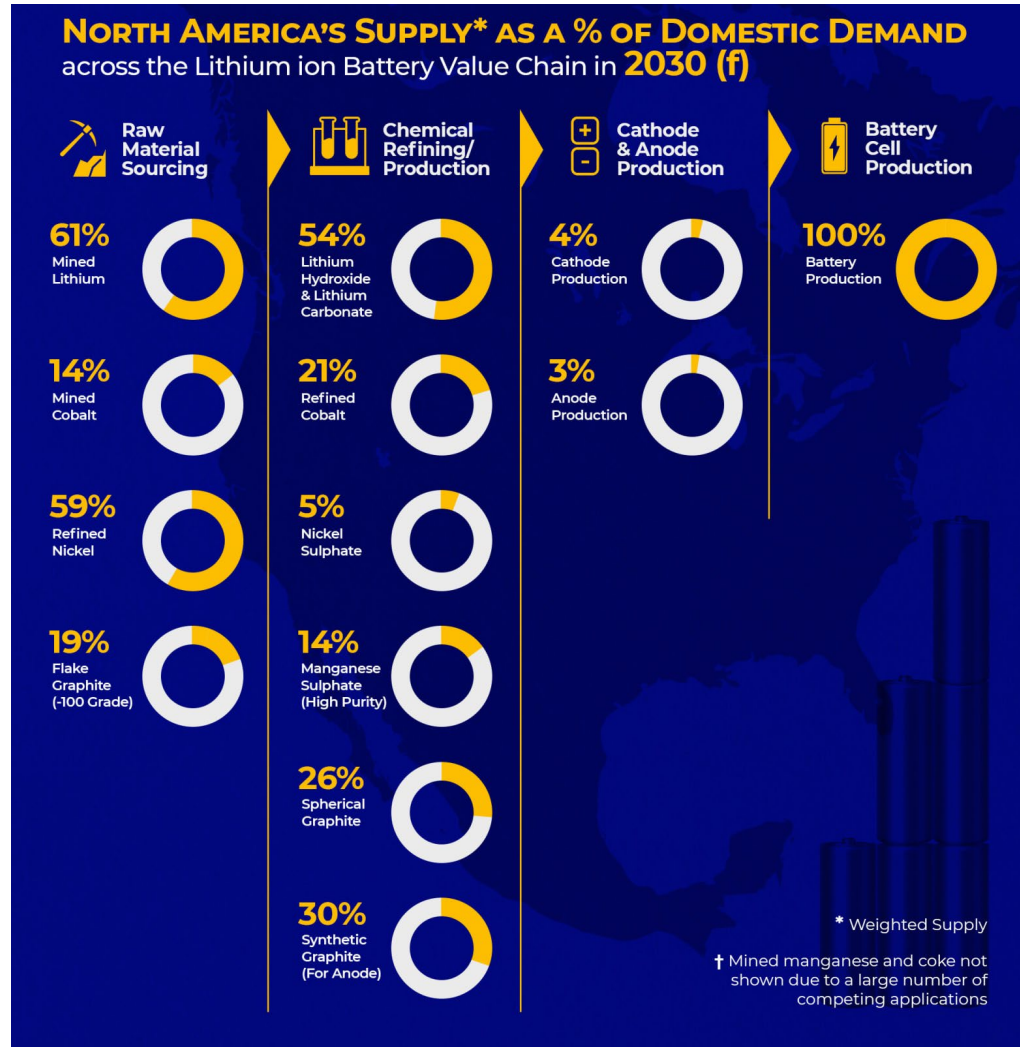

For further information on Benchmark Mineral Intelligence products, please contact info@benchmarkminerals.com.

HOW MANY MINES DO WE NEED?

As the lithium ion battery revolution gains momentum, **Benchmark** forecasts just how many mines need to be built to keep up with the exceptional volumes of demand for key raw materials expected by 2035.

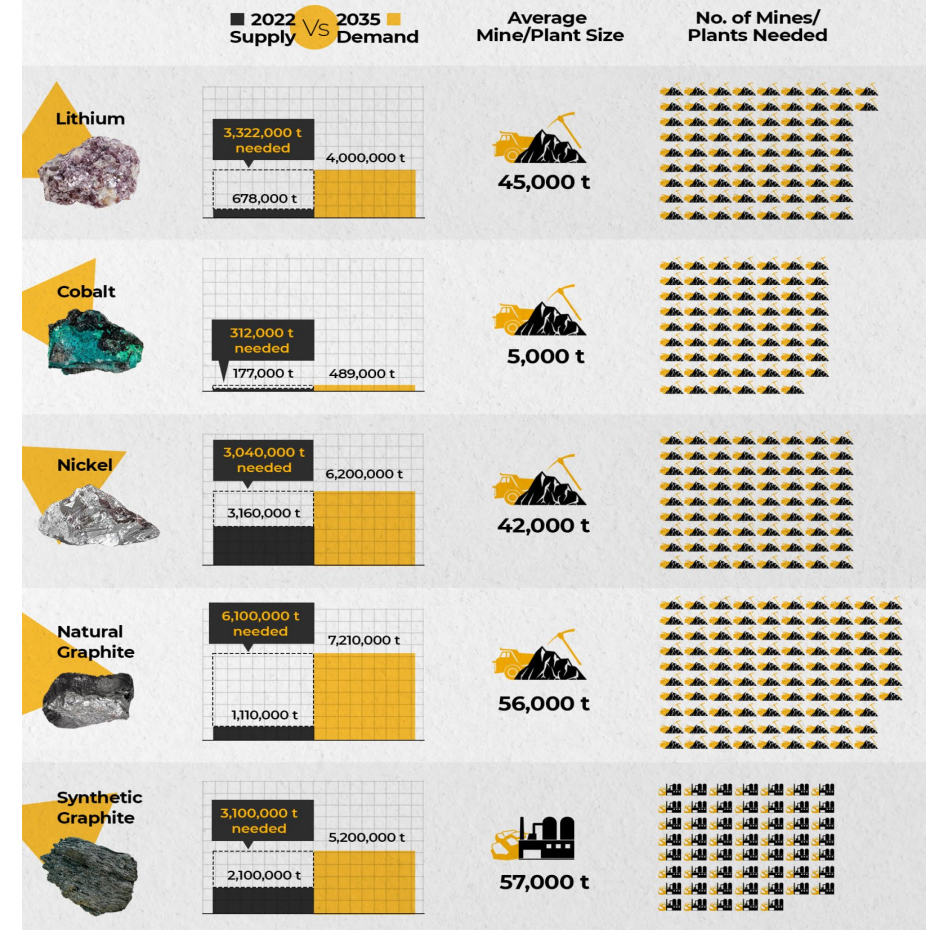

For further information on Benchmark Mineral Intelligence products, please contact info@benchmarkminerals.com.

Sources:

- Benchmark Minerals Intelligence, "Can North America Build a Battery Supply Chain?" (Nov. 17, 2022) <https://source.benchmarkminerals.com/article/can-north-america-build-a-battery-supply-chain>
- Benchmark Minerals Intelligence, "More than 300 new mines required to meet battery demand by 2035", <https://source.benchmarkminerals.com/article/more-than-300-new-mines-required-to-meet-battery-demand-by-2035>

Key Drivers of EV Rejection: Charging & Price

Latest J.D. Power intel shows **charging and price persist as key barriers**

Rank			Rejection Reason		July	Δ
Aug	Jul	Δ	August	Percentage	July	Δ
1	1	0	● Lack of charging station availability	48%	48%	0%
1	2	+1	● Purchase price	48%	46%	+2%
3	3	0	● Limited driving distance per charge	44%	40%	+4%
4	4	0	● Time required to charge	41%	37%	+4%
5	5	0	● Inability to charge at home or work	38%	34%	+4%
6	5	-1	Cost of ownership	33%	34%	-1%
7	7	0	Power outage/grid concerns	32%	30%	+2%
8	8	0	Inadequate reliability (including battery life)	28%	27%	+1%
9	9	0	Lack of available/capable repair/service centers	20%	19%	+1%
10	11	+1	Inadequate performance in extreme temperatures	19%	16%	+3%
11	10	-1	Functionality and/or capacity limitations	18%	18%	0%
12	12	0	Negative environmental impact	16%	15%	+1%
13	14	+1	Inadequate overall performance	13%	11%	+2%
14	13	-1	● Lack of clarity on resale value	11%	12%	-1%
15	15	0	● Lack of clarity on applicable incentives, tax credits, subsidies	10%	10%	0%
16	15	-1	● Lack of clarity on applicable utility rate adjustments	9%	10%	-1%
16	17	+1	Feature and/or technology limitations	9%	8%	+1%
18	17	-1	Negative economic impact (loss of jobs, etc.)	8%	8%	0%
18	19	+1	Preferred brand doesn't currently offer a suitable EV model	8%	7%	+1%
18	21	+3	Criticism from other sources (e.g., 3rd-party websites, etc.)	8%	6%	+2%
21	21	0	Inadequate styling/image	7%	6%	+1%
22	19	-3	● Lack of helpful information from dealership/store	6%	7%	-1%
22	24	+2	Critical input from family or friends	6%	5%	+1%
24	21	-3	● Lack of helpful information from brand website	5%	6%	-1%
25	24	-1	Other	4%	5%	-1%
26	26	0	Negative past experience with EVs	3%	3%	0%

● CHARGING

- 4 of the top 5 reasons for EV rejection relate to charging
- All told, 76% of EV rejecters cite at least one charging-related concern

● PRICE

- 48% of rejecters cite *Purchase Price*
- *While Total Cost of Ownership is good, initial purchase price is challenging for many consumers*

● LACK OF INFORMATION

- All told, 30% of rejecters cite a **lack of information**, including resale value, incentives, tax credits, etc.

Source: J.D. Power EV Consideration (EVC) Monthly Pulse

Public Charging Reliability

1 in 5 EV owners who attempt to charge at a public location are unable to do so

Imagine if 20% of the time, the gas station you went to was closed

Requiring reliability and performance standards for infrastructure funding can help

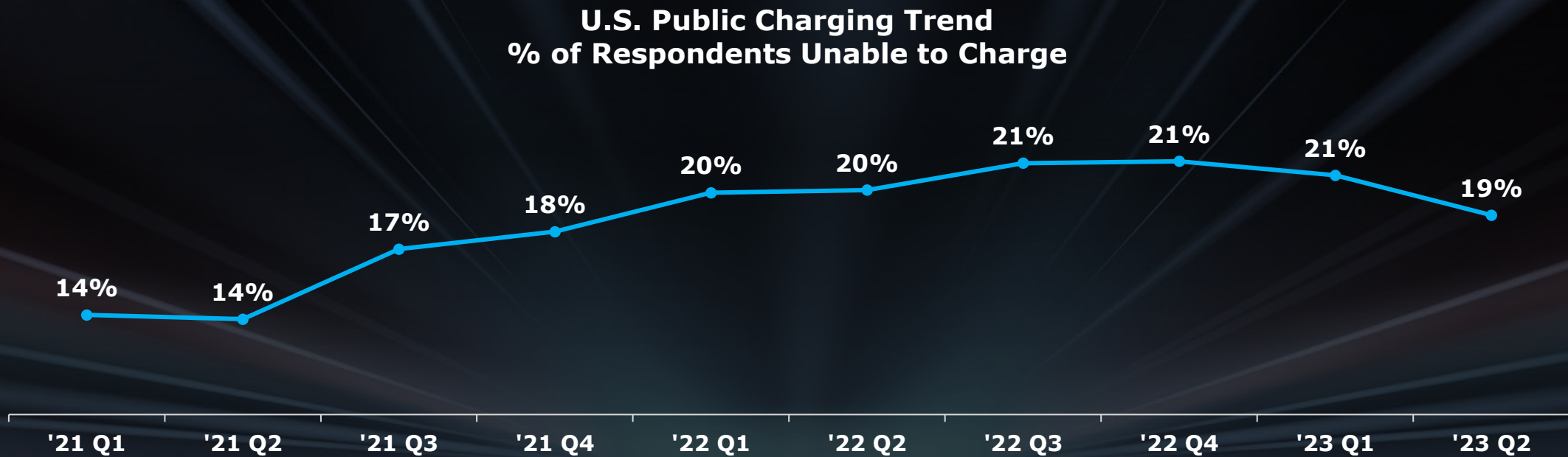

Source: J.D. Power U.S. EV Experience (EVX) Public Charging Study

State Policies and Regulations Shape the Market Landscape for EV Charging

- **Policy mandates and goals (e.g., ZEV sales, charger deployments)**
- **Charger and make-ready incentives (e.g., grants, rebates, tax credits)**
- **EV-ready building requirements (e.g., state legislation, building codes)**
- **Market economics (e.g., clean fuels standards, carbon credits, EV fees)**
- **Sector focus areas (e.g., multifamily, low income, rural, transit, school bus, truck)**
- **Compliance requirements (e.g., data reporting, cybersecurity, uptime)**
- **Utility and grid integration (e.g., managed charging, demand response, bidirectional charging, interoperability)**



State Policies for Effective EV Deployment

What strategies have state EV leaders enacted?

- **Prioritize EVs for state and private fleet purchases**
- **Invest and commit to sustained and well-funded state-level point-of-sale EV incentives**
- **Commit to EV fueling Infrastructure buildout: incentivize charging and hydrogen refueling stations**
- **Update building codes for new construction and retrofits to require EV-ready charging**
- **Implement a low carbon fuel standard (LCFS)**
- **Engage utilities and assess the resiliency of the electric grid**
- **Be aware of roadblocks**

STRATEGY: Electrifying Fleets

Several states have prioritized EVs for state fleets:

- States can lead by example
- Requirements for fleet percentages
- Govt fleets and private fleets (rental car companies)
- Potential for cost savings

ZEV States (~ 35% of U.S. Market)



EV Purchase Incentives

Why should states incentivize EV purchases?

- Electrification will be felt nationwide – ACC2 and EPA states
- IRA void
- EV prices coming down, but still costlier than ICE vehicles
- Automakers offering more EVs than ever before
- Effectiveness of purchase incentives

Powertrain Options

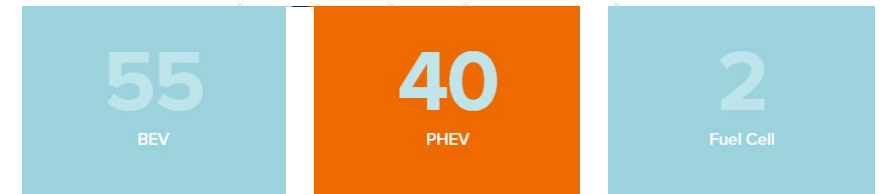

Means testing

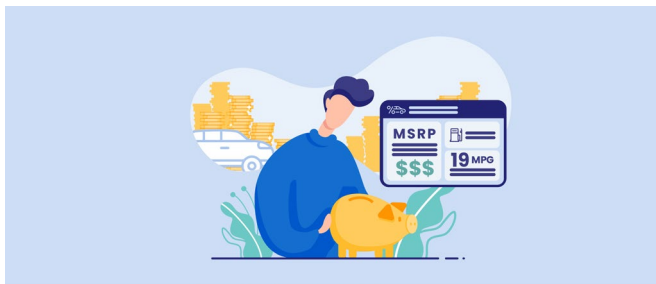

Vehicle eligibility



LMI/accessibility

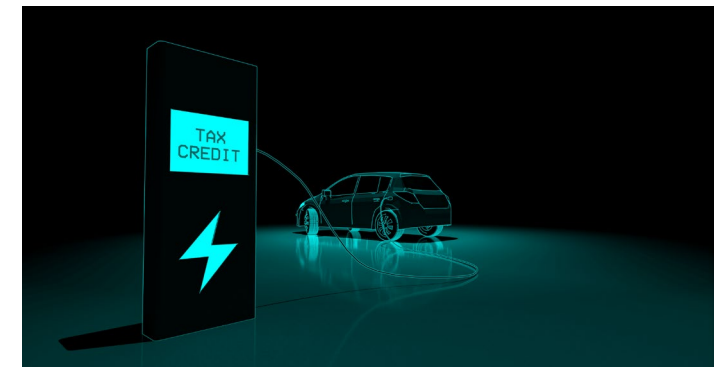

Retail – New EV Tax Credit (30D)

2025CY

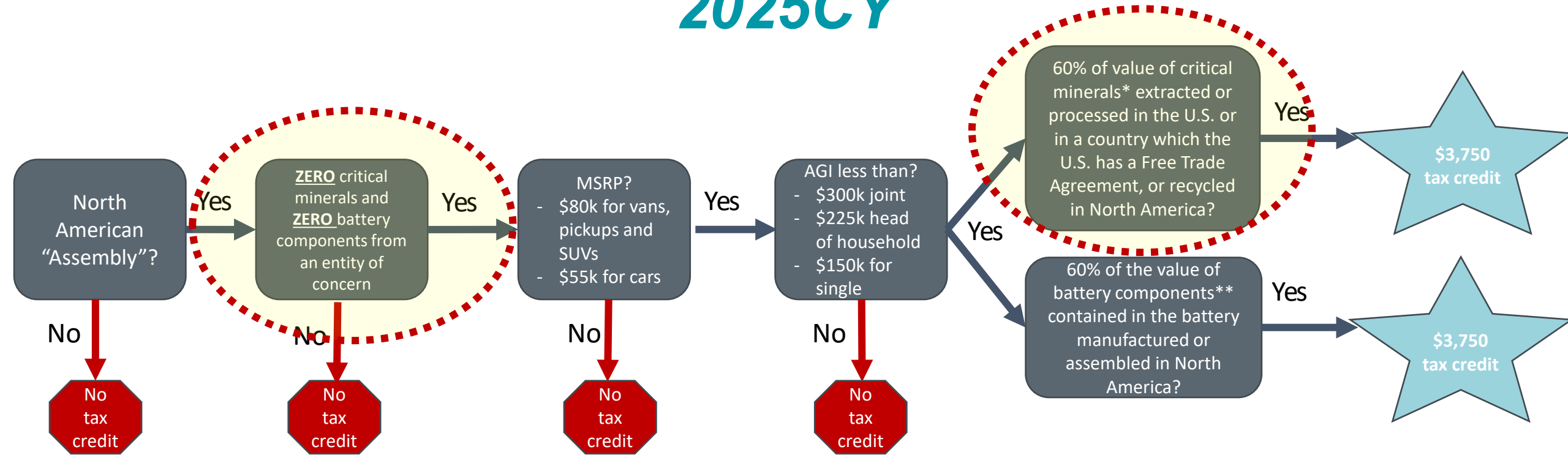

*Critical Minerals:

- Before CY2024 – 40%
- 2024 – 50%
- **2025 – 60%**
- 2026 – 70%
- After 2026 – 80%

**Battery Components:

- Before CY2024 – 50%
- **2024-2025 – 60%**
- 2026 – 70%
- 2027 – 80%
- 2028 – 90%
- After Dec. 31, 2028 – 100%

Notes:

1. All of the above is Auto Innovators staff interpretation of legislative language and pending Department of Treasury draft guidance to be issued by the end of December 2022
2. MSRP and AGI are not indexed to inflation
3. Critical minerals are calculated as the critical minerals contained in such a battery as certified by the manufacturer
4. Battery components are calculated as the value of components contained in such a battery as certified by the manufacturer
5. Excluded entities (China, Russia, Iran, North Korea):
 - Starting Jan. 1, 2024, no components contained in a battery of such vehicle can be manufactured or assembled by an entity of concern. **This makes a vehicle placed in service after 12/31/2023 ineligible**
 - Starting Jan. 1, 2025, no applicable critical minerals contained in a battery can be extracted, processed, or recycled by a foreign entity of concern. **Vehicle placed in service after 12/31/2024 is ineligible.**
6. Aggregate battery capacity must be greater than 7 kWh

STRATEGY: Engage Utilities and PUC

- For utilities to make any investment, funding must be approved by the state public utilities commission (PUC) or public service commission (PSC), including EV charging infrastructure.
- Utilities can support EV charging by: making grid upgrades, installing EV chargers, building out the necessary make-ready infrastructure, owning and operating EV charging stations, EV-specific rate design.
- Legislators can direct PUCs or PSCs to direct their utilities to develop transportation electrification plans to allow them to invest in EV charging.

ZEV States (~ 35% of U.S. Market)

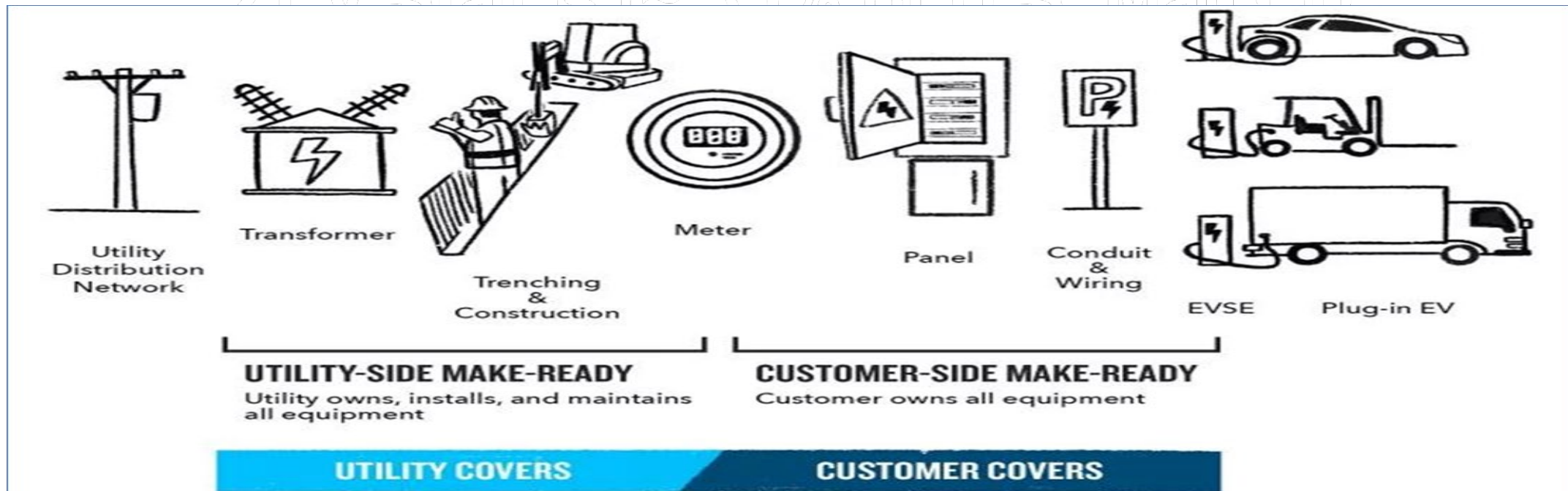

STRATEGY: Updated Building Codes

According to the U.S. Dept. of Energy, about **80% of EV charging occurs at home/ work.**

Home charging is more reliable, more convenient, and 2-3 times less expensive making access to home charging a top priority for customers considering an EV.

Installing EV infrastructure at the time of new construction is by far the least expensive way to build EV charging access.

- California will save up to \$1.4 billion by installing charging upfront, rather than retrofitting later.

States updated their building codes to require:

- Residential building codes to require EV-ready charging capabilities in 100% of parking spots in new MUDs and single-family homes
- Installation of EV-ready charging capabilities in a significant portion of all new parking at workplaces and at public parking
- Install the same infrastructure during any significant renovations



Other EV Charging Infrastructure Challenges & Considerations



The transportation and electric power sectors have **evolved independently**.



Electrifying transportation therefore requires **rapid collaboration** between entities that haven't historically worked together.

Transportation electrification is occurring on top of an existing system, with legacy issues

Existing Equity Issues in Transportation

- Transportation energy burden
- Access to affordable financing
- Local pollutant concentrations / poor public health outcomes
- Urban sprawl, gentrification (e.g., super commutes)
- Urban renewal / redevelopment
- ...

New Challenges Posed by EVs

- Affordability, availability of vehicles
- Charging access (home, public)
- Charging “deserts”
- Investment required (public, private)
- Infrastructure development (siting locations and process)
- Grid reliability (fuel source)

Opportunity to address historic challenges
Imperative to avoid creating new ones

Early EV & charging deployment highlights equity challenges...and potential opportunities

• Case Study: Ridehailing in Los Angeles

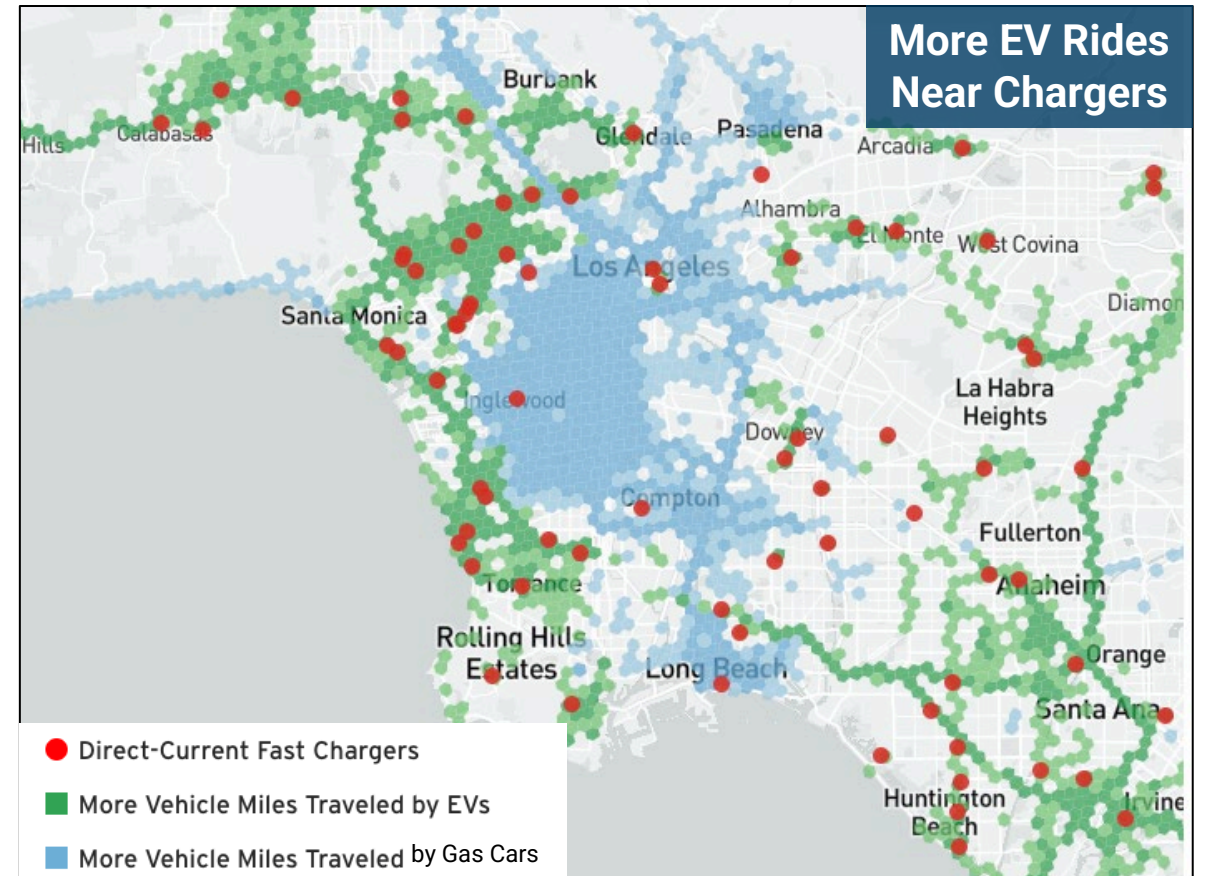
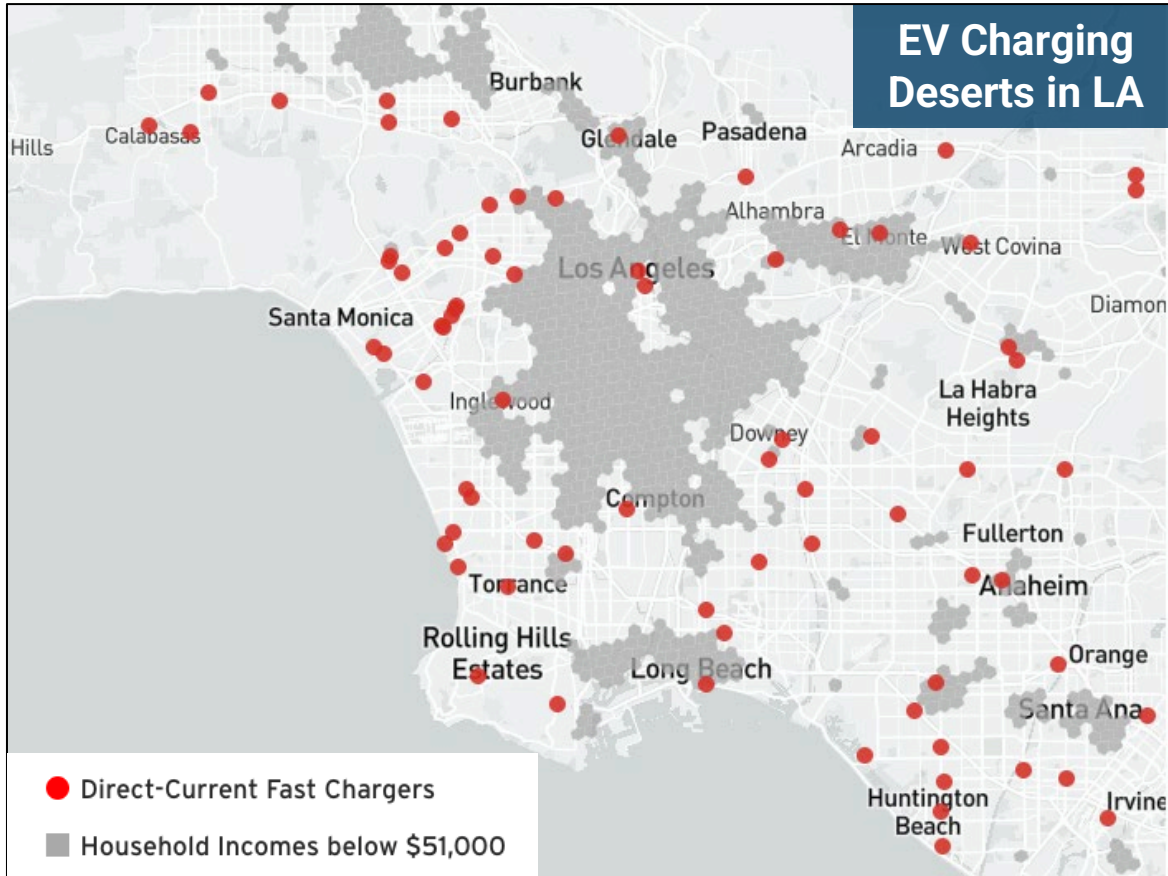

Low-Income Areas in Los Angeles Lack DCFC Infrastructure

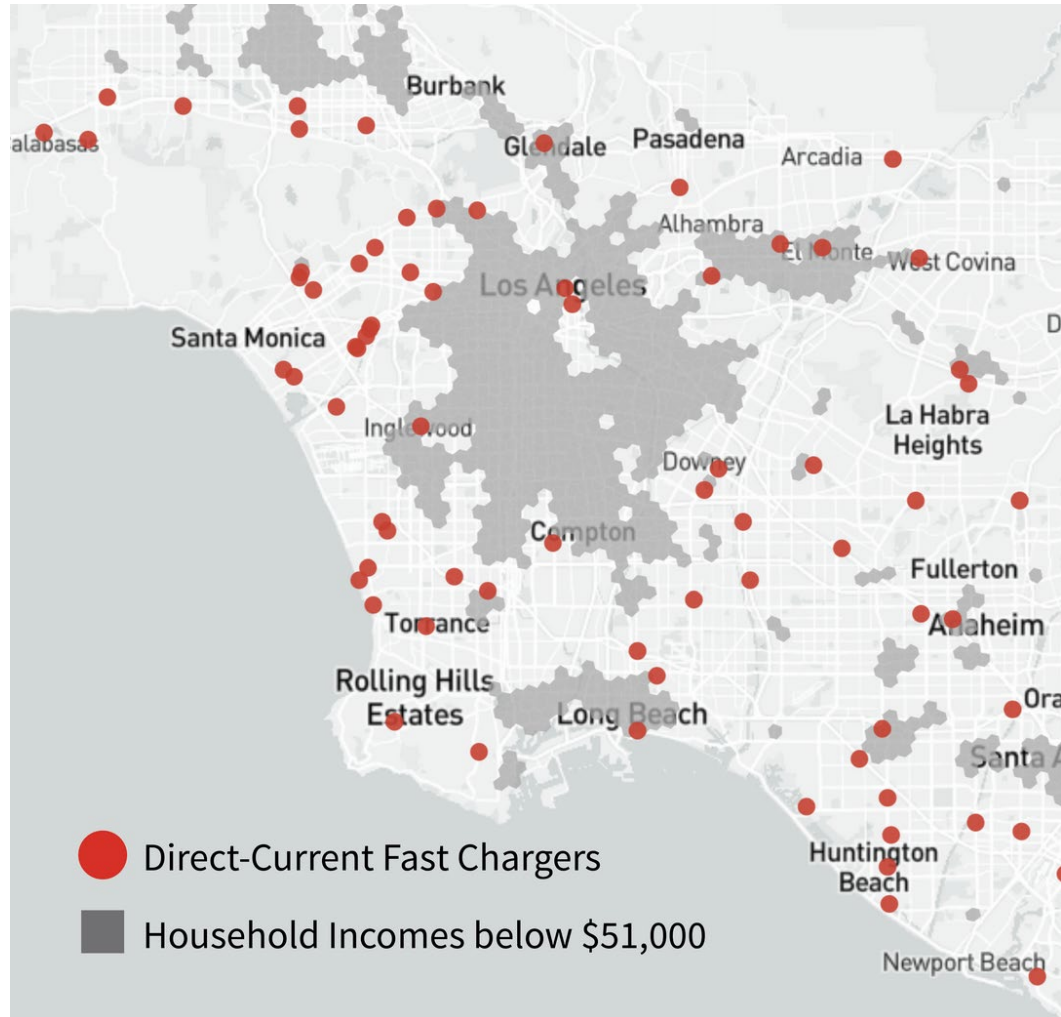

The lack of infrastructure in low-income areas:

- 1) Forces more gasoline TNC miles into low-income communities
 - At 50% TNC electrification, this can mean 5,000-8,000 more gasoline miles per square mile per day along the I-110 corridor
 - ICE vehicle emissions exacerbate negative health and environmental impacts in low-income areas
- 1) Is a barrier to EV adoption for residents of low-income areas, who especially need public charging infrastructure (including TNC drivers)

Important to remember – EV equity must also consider rural populations

- Rural parts of U.S. have distinct needs and challenges from urban metro areas

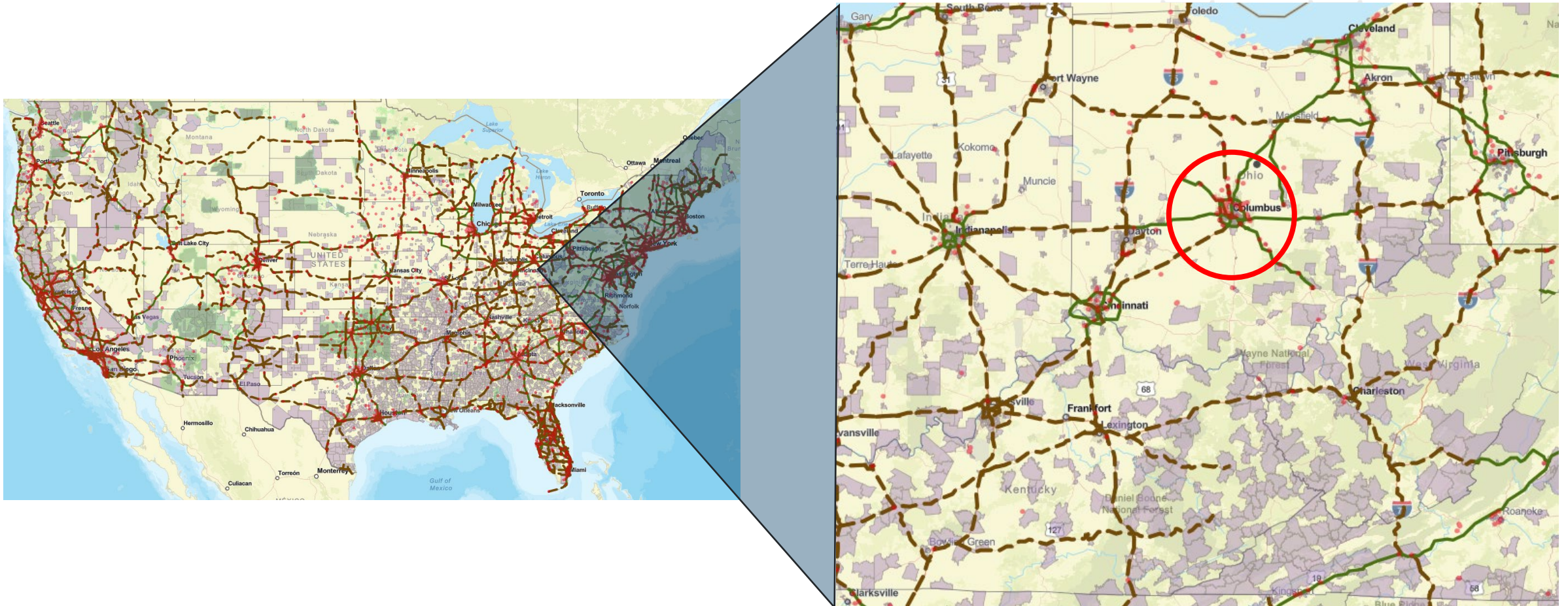

What tools exist to address barriers?

- Policy focus areas and strategies to overcome key barriers (select examples)

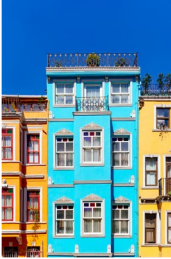

Affordability & Accessibility

- Dedicated funding for LMI, DAC
- Invest in EV charging deserts
- MFH charging
- DCFC affordability
- EVSE building codes



Charger Performance

- Public charger reliability
- Interoperability, standards harmonization
- Managed charging
- Accessibility (language, payment)
- Attention for rural areas



Governance & Incentives

- Targeted EV purchase / lease incentives
- Workplace charging programs / incentives
- Market-based incentives (e.g., LCFS)
- Streamlined permitting processes
- Education, outreach, tech. assistance



Electric Utilities

- Grid upgrade cost sharing / support
- EV-specific tariffs
- Transparent capacity availability
- Regulatory certainty for EVSPs
- Dedicated TE teams



Medium-/Heavy-duty Vehicles

- MHD vehicle incentives
- MHD charging incentives
- MHD sales requirements
- Proactive planning for grid needs
- Co-location with on-site gen. / storage



Don't Forget About Hydrogen

Hydrogen Fuel Cell Vehicles – Another Tool in the Box

The Vehicle

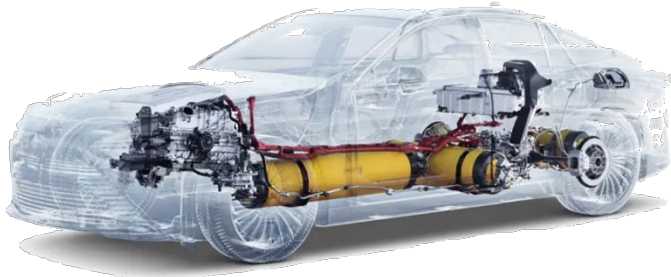

Electric Powertrain –
Smooth, Quiet

Fuel Cell creates
electricity from hydrogen

Zero Emissions

Long Range (300-400 miles)

No plugging in – park anywhere

Scalable – increase range
without too much weight

The Station



Quick - fill in 3-5 minutes



Universal – no plug matching,
no network memberships

Central – one station supports
many cars per day

Small grid impact – no system
upgrades

The Fuel

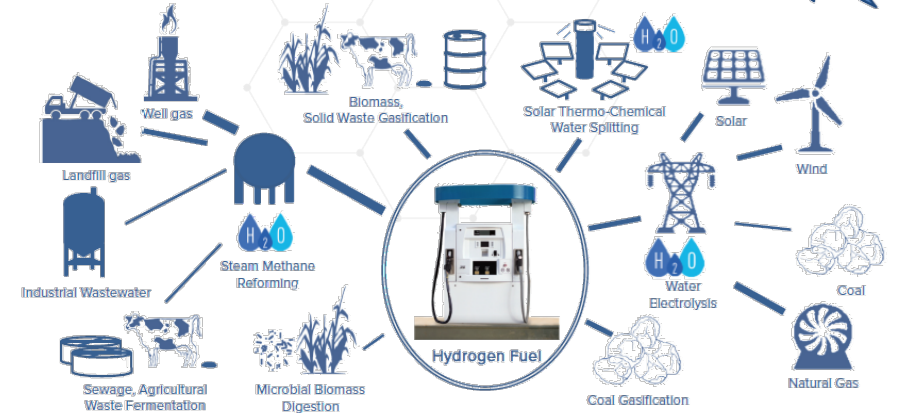

Flexible - many sources, including waste

Can be low- or negative-carbon

Can be independent of the grid –
no strain on generation

Can be produced using excess
renewable electricity

Storable – no load balancing

Hydrogen and fuel cell vehicles will enable faster and deeper decarbonization of transportation than electric plug-in vehicles alone

Fuel Cell Applications



Factors of Success

Plan



Stability

Coordination

Growth

Policy

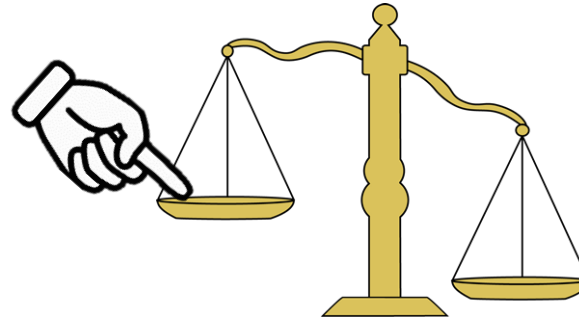

Funding

Incentives

Performance

Partners

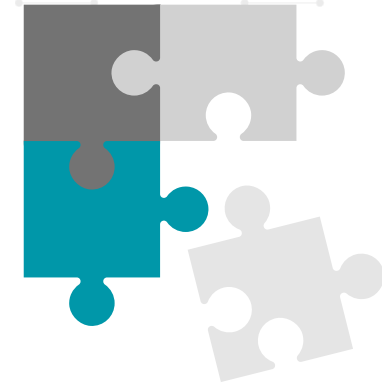

Vehicles

Infrastructure

Customers

Summary

FCEVs are a necessary tool to achieve rapid, deep decarbonization



Successful implementation requires

Plan



Policy

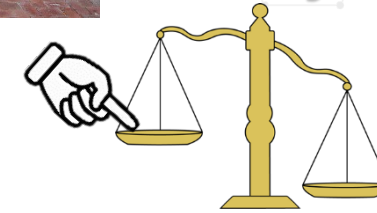

Partners

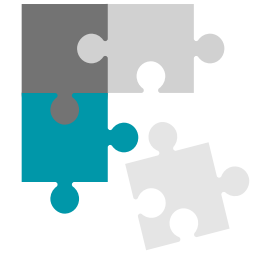

States can take advantage of new Federal Funding



EV Battery Safety

EV Battery Safety

Electric Vehicles Have Been Subject to High-profile Recalls over Fire Risk



Sensationalized Media Coverage over Fires & Water Usage to Dose Fires

EV Battery Safety

National Transportation Safety Board Data

- Gasoline-powered cars - **1,530** fires per 100,000 sold
- Electric Vehicles - **25 fires** per 100,000 sold

National Highway Traffic Safety Administration

*“Despite the focus on EV fires in the news, they are **not inherently more dangerous than gas** or hybrid vehicles, although electric fires tend to be more difficult than gas fires to extinguish.”*

EV Battery Safety

National Fire Protection Association [NFPA] recognized the need to develop best practices and training materials for firefighting, transport, and storage for EVs.

Auto Innovators worked with the NFPA to develop its “Best Practices for Emergency Response to Incidents Involving Electric Vehicles Battery Hazards.**”**

The NFPA maintains a list of the automakers’ Emergency Response Guides

EV Battery Safety

Other Issues with Lithium-ion Batteries Impacting EVs

- **Labeling Requirements**
- **Shipping Practices**
- **Storage Practices**
- **Filing Requirements/Safety Reports**

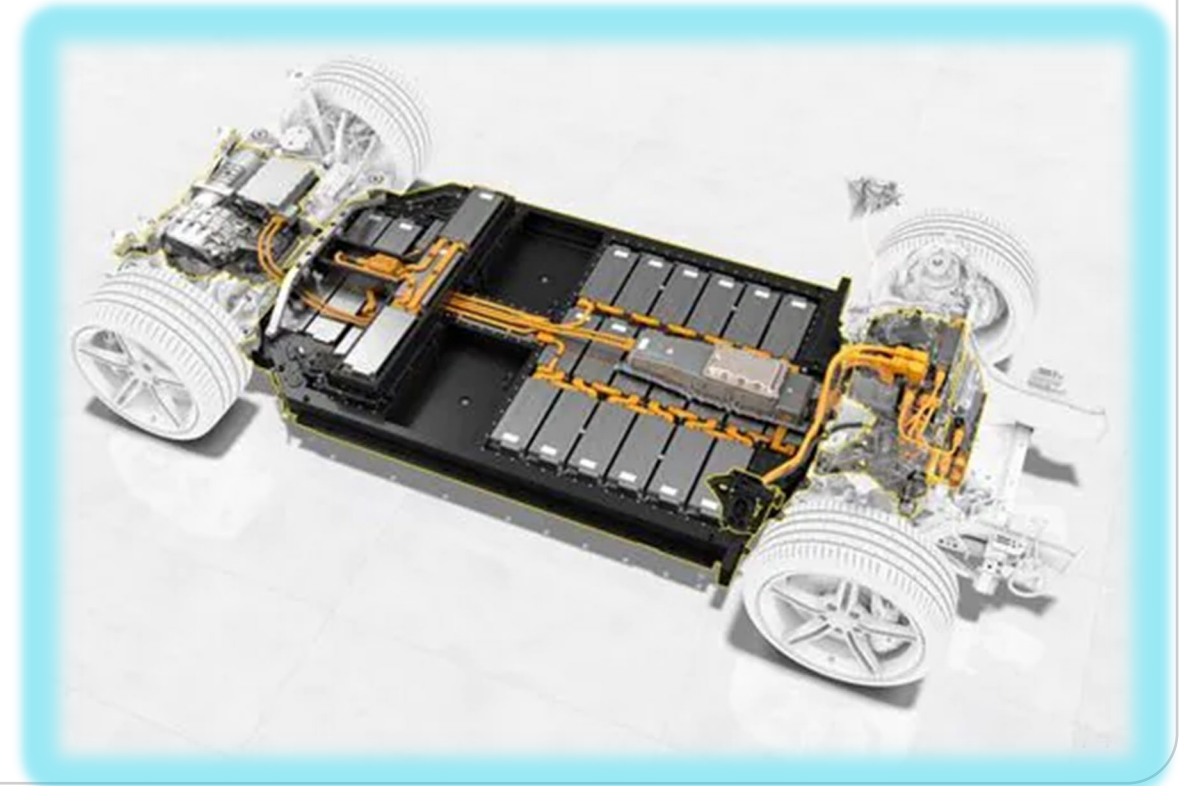

EV Battery Safety

Issues/Bills Targeting Lithium-ion Batteries

- **e-bikes**
- **e-scooters**
- **other micro-mobility devices**



...can Inadvertently Include EV Batteries



EV Battery Recycling & Reuse

EV Battery Recycling

Opportunities for Used EV Batteries

REDUCE: Refurbishing battery modules to good as new through the replacement of worn or deteriorated components and re-certifying to OEM specifications.

REPURPOSE: Utilizing EV battery components to fulfill a different use from what was originally intended.

RECYCLE: **Recovering** maximum amount of raw materials for reuse in identical or alternative industries.



EV Battery Recycling

Li-Ion Battery Recycling Opportunity

Domestic battery recycling can:

- Provide national energy security
- Reduce our dependency on foreign nations for materials
- Create domestic jobs
- Lower EV battery costs
- Stabilize critical mineral supply chain
- Enhance lifecycle environmental footprint

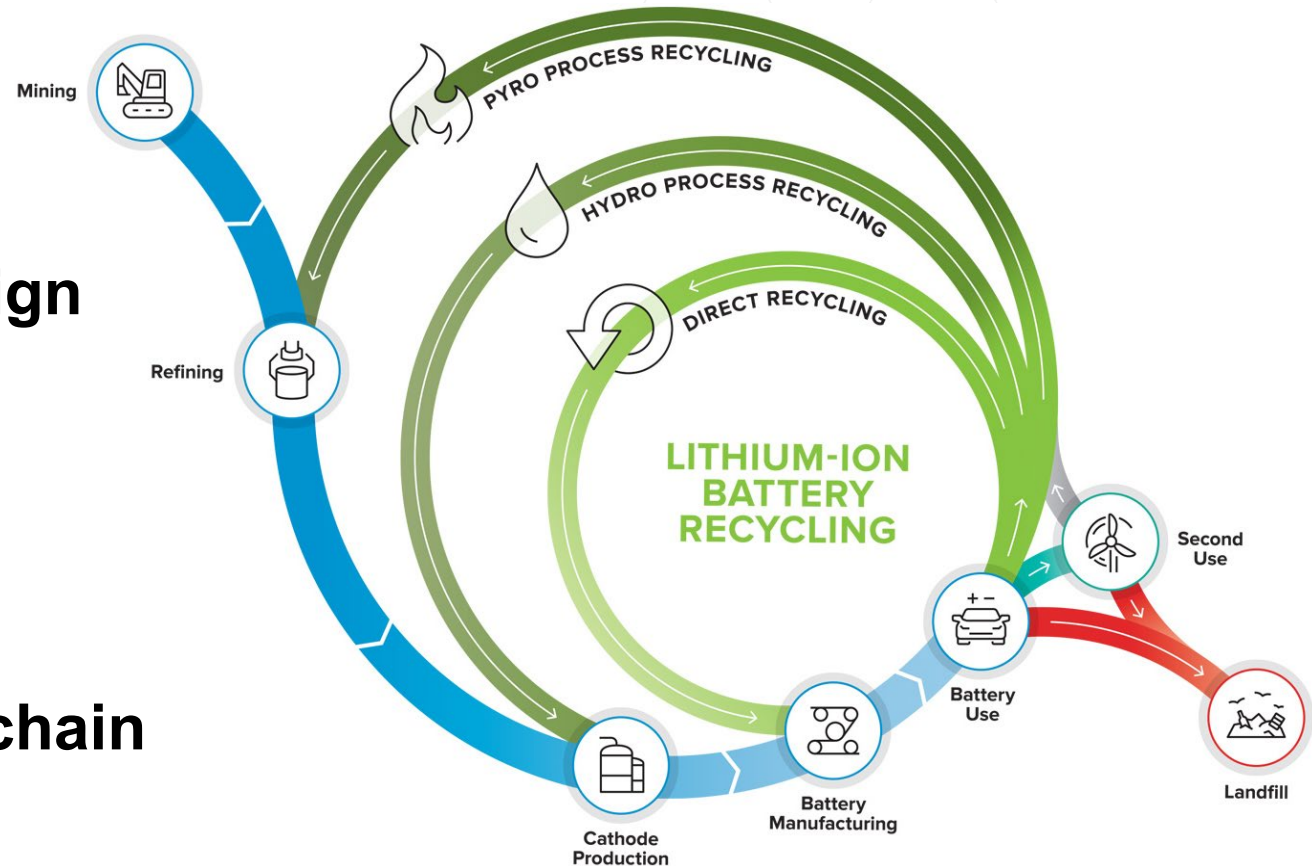

EV Battery Recycling

- Lithium-Ion Car Battery Responsibility Timeline

Battery Warranty Period:
Auto Manufacturers

Battery Replacement:
- Core Exchange
(Dealerships, Repair Shops, Collision Shops)

Vehicle End-of-Life:
Dismantler
(w/Auto Manufacturer Complete Vehicle “Back-stop”)

Non-vehicle Secondary Use:
Non-vehicle secondary use
Owner Responsible unless stated otherwise in a contract

Example Use Case: In-Service, Under Warranty

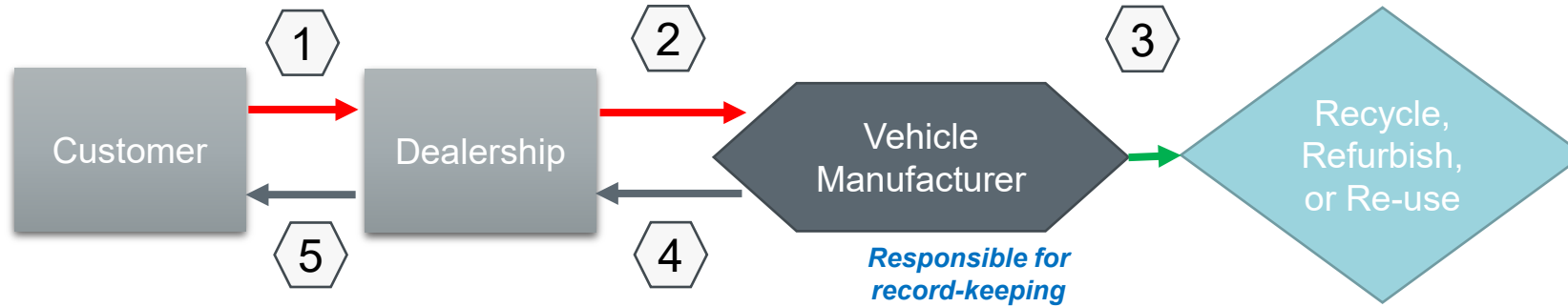

1. Customer drops vehicle at dealer for repair
2. Dealer removes battery
3. Vehicle manufacturer ensures EV battery is properly recycled, refurbished, or put into a non-vehicle secondary-use
4. Vehicle Manufacturer provides a replacement battery to the dealer
5. Dealer provides repaired vehicle to customer

Example Use Case: In-Service, Outside Warranty

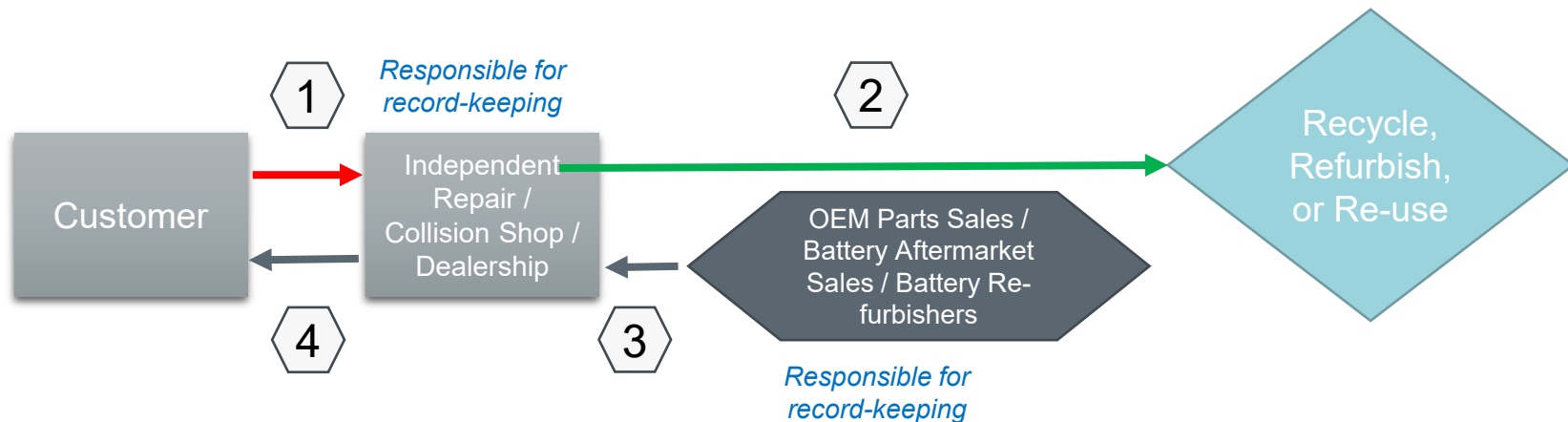

1. Customer drops vehicle at shop for repair
2. Shop removes battery and ensures that is properly recycled, refurbished, or put into a non-vehicle secondary use
3. OEM / aftermarket / battery re-furbishers provides battery to repair shop through a core exchange program
4. Repaired vehicle is delivered to customer

EV Battery Recycling

Why the Complete Vehicle Backstop is the Appropriate Policy

- Traditional EPR schemes are appropriate for **negative recycling value products, limited secondary life opportunities, and/or natural resource-intensive recycling technologies.**
- **Complete Vehicle “Back-stop”:**
 - Ensures EV batteries are properly reused, refurbished, or recycled throughout their life-cycle in the vehicle
 - Likely would not increase the cost of electric vehicles for consumers
 - Ensures licensed dismantlers are not “cut-out” of the market at end-of-life
 - If the complete vehicle is a positive business case, licensed dismantlers will continue to acquire end-of-life EVs
 - If the battery becomes positive value at end-of-life, it does not take away this opportunity for dismantlers (like EPR might)
- **Encourages auto manufacturers to continue to design for recycling and reuse**
- **Does not discourage innovation amongst recyclers**
- **Encourages dismantlers to become “licensed”**
- **Complete vehicle is easier, safer, & less expensive to transport than a separate battery**



Road Infrastructure Funding

The Gas Tax is Failing

Why a once great policy is no longer keeping pace.



Gas Tax Basics

- **What is it?** Tax levied on gasoline at both the federal and state levels, to provide funds for highway repair and maintenance, as well as for other government infrastructure projects.
- **Paid Per Gallon.** Generally apply a fixed cents-per-gallon tax when a consumer fills up their tank at the gas station.
- **History.** Oregon was the first state to impose a tax on gasoline in **1911** and by **1932** every state had followed suit and Congress enacted a 1-cent-a-gallon federal tax.



Why the Gas Tax is Great

- **User Fee.** Users pay in proportion to the amount of wear and tear they inflict on the roadways.
- **Invested back into the roads.** User fee is invested back into road construction and maintenance.
- **Easy to administer.** By taxing at the pump at a fixed rate per gallon, the administration of a gas tax is relatively easy and inexpensive (less than 1% of revenues).

But the gas tax is doomed

- **Gas tax revenues have not kept pace with inflation.**
- **Vehicle efficiency** has further eroded the gas tax.
- **And its tax base is narrowing thanks to the emergence of hybrid and electric vehicles.**

#1 Inflation

- The federal gas tax of 18.4 cents hasn't increased in 30 years and is not indexed to inflation. In real terms, the gas tax has **lost almost half its value** since its last increase in 1993.
- Generally, states have been better:
 - Since 2013, **32 states** have increased their gas tax;
 - **23 states** use a variable rate or index to inflation
 - But even the states are mostly **treading water**
 - **Suspension** of some gas taxes in 2022
- Unless lawmakers enact new increases on a regular basis, **inflation alone will eat away at gas tax revenues.**

#2 Fuel Efficiency

- **Fuel efficiency** for all vehicles in the U.S. **increased by 100%** from 1975 to 2022.
- Average **mpg** increased from **13.1 to 26.4**.
- Great for consumers but **bad news for gas tax revenues**.

#3 Hybrids & EVs

- Emergence of hybrid and EVs is the true **existential crises** facing the gas tax.
- EVs **skip the pump altogether**, so EV drivers pay zero gas taxes.
- EV numbers are limited now, but will rapidly increase.

Bonus: Construction Costs

- **Purchasing power diminished.**
- Construction and maintenance costs **rising faster than inflation.**
- In last 2 years highway construction costs **increased by 50%**
- **Often more emphasis on costlier new construction** over lower costing maintenance projects

National Highway Construction Cost Index (NHCCI)

Select Year and Quarter:
2003 Q1 2022 Q3

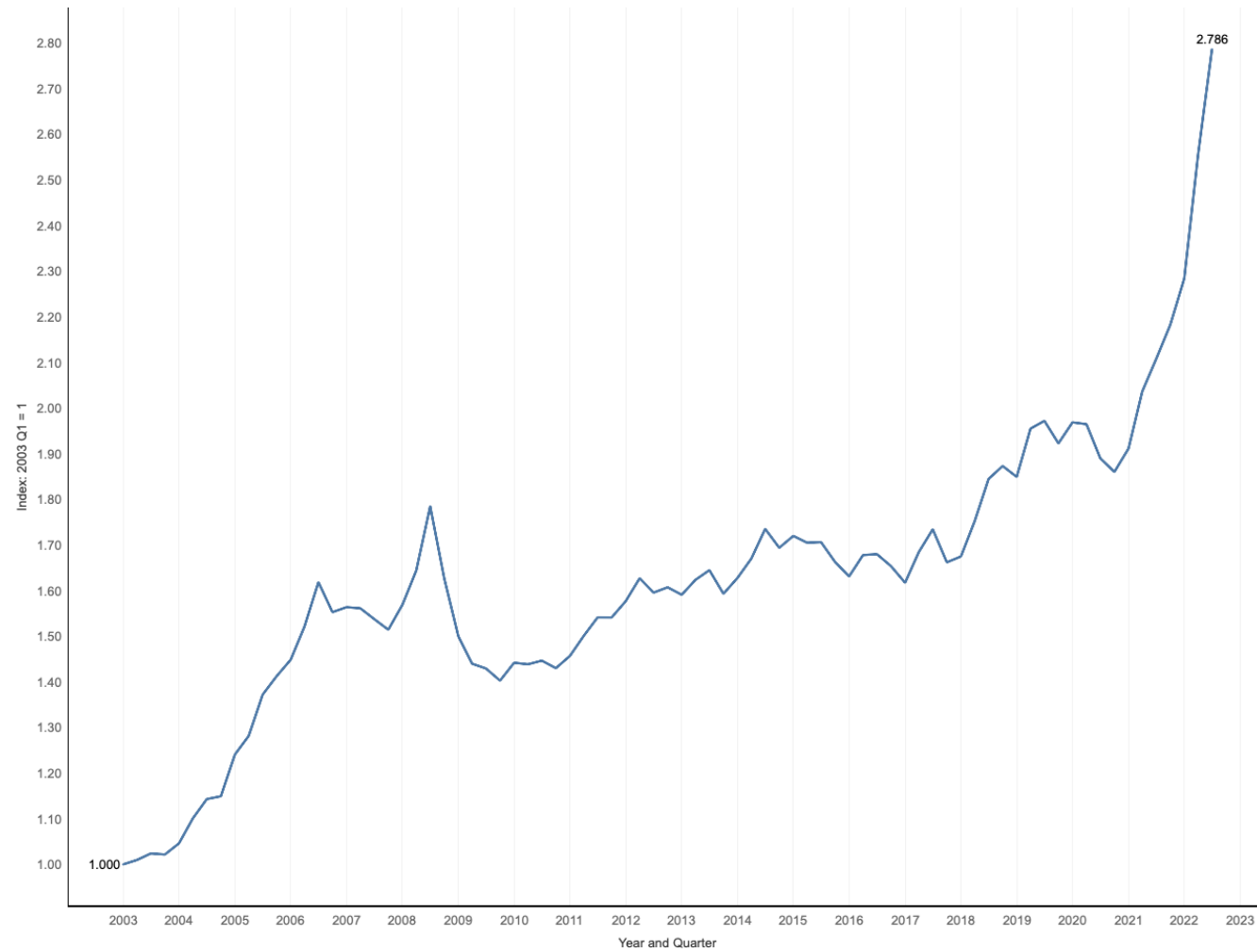

2022 Q3 index is preliminary.
2022 Q1 and 2022 Q2 indexes are revised.



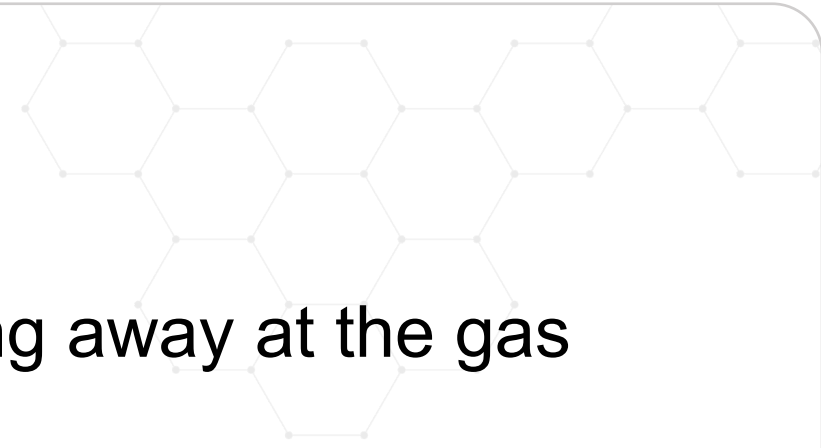

What can be done?

- Inflation, fuel efficiency, and EVs are chipping away at the gas tax.
- But what are the alternatives?...



Tax the Vehicle with an **EV Fee**

Tax the road with **VMT Taxes**



Tax the electricity with **kWh Taxes**

Options to Replace Gas Tax

Road Funding Options – EV Fees

EV fees are the worst way to fund roadway infrastructure



Regressive tax, unrelated to usage of fuel or public good



Financial hardship, as collected all at one time



Does not capture non-resident usage of roadways



Disincentive to purchasing EV



Adds to upfront money consumers need to purchase EV

Road Funding Options – VMT Taxes

VMT offers new path to capture actual usage of public good



Progressive tax, increases with more usage of road/fuel



Not increasing upfront money needed to buy vehicle



Does not capture non-resident usage of roadways



GPS tracking needed to offset out-of-state driving



Principle of VMT taxes not generally liked by vehicle owners

Road Funding Options – VMT Taxes

VMT Principle of VMT taxes not generally liked by good vehicle owners:

**San Jose State Study – 61% Opposed
of that 40% Strongly Opposed**

Target on EVs creates disincentive to buy

Prog
tax, in
with
usage or
road/fuel

vehicle

usage or
roadways

state driving

by vehicle
owners

of VMT
is not
ly liked

Where we are going...

California ACC II – ZEV Mandate

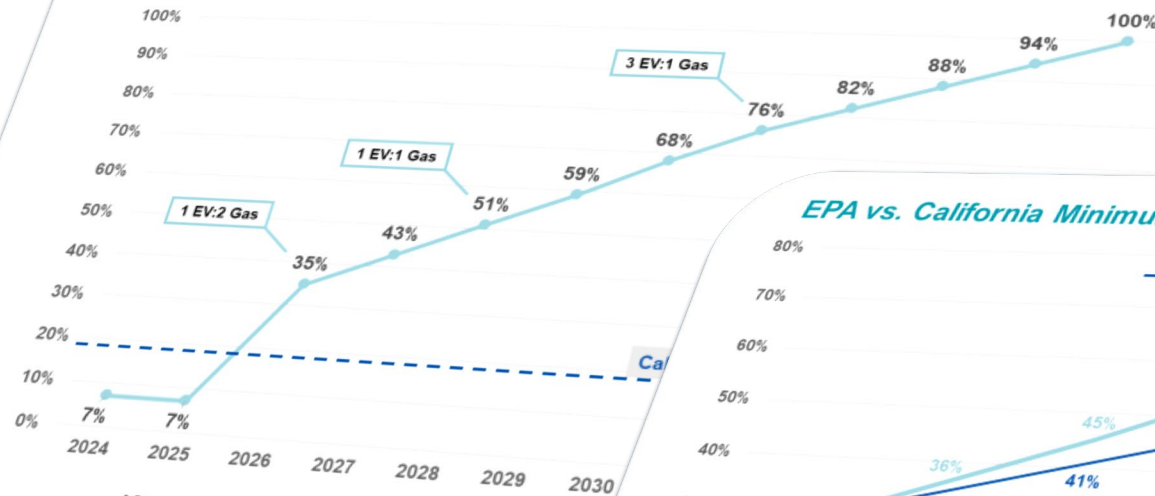

* See: <https://www.autosinnovate.org/resources/electric-vehicle-sales-d>

EPA vs. California Minimum BEV⁽¹⁾

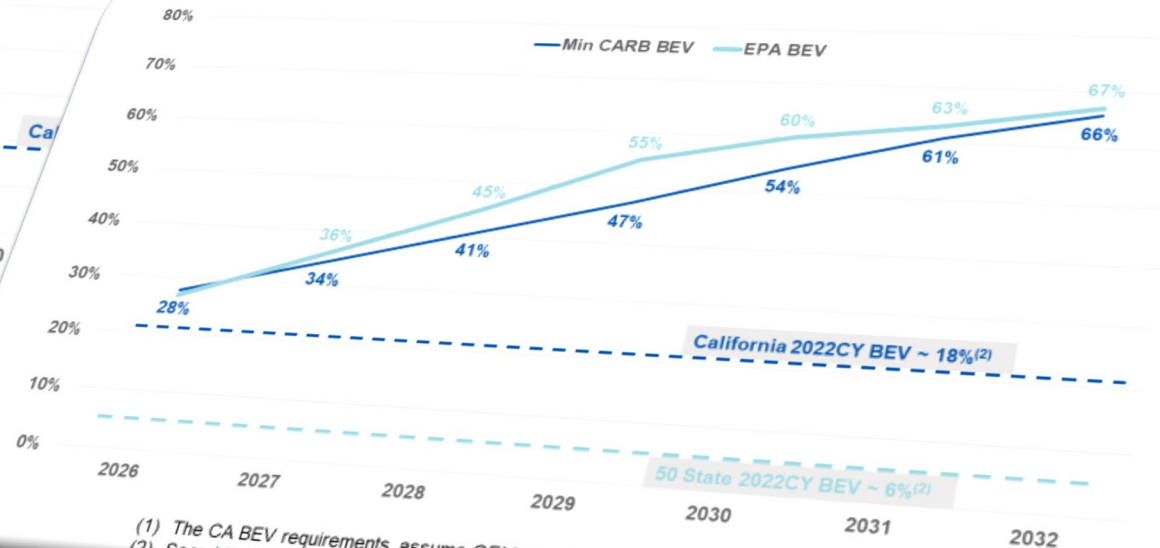

(1) The CA BEV requirements assume OEMs maximize PHEVs (e.g., 14% PHEVs in 2030MY)
 (2) See: <https://www.autosinnovate.org/resources/electric-vehicle-sales-dashboard>

6

...we cannot only sell to 39%

Road Funding Options – kWh Taxes

kWh taxes may be a better progressive tax

Also:
Challenges setting just **correct rate** to capture expected revenues

Changes in utility rate structure are **long and tortured paths**



Progressive tax, ties road user contributions to amount of fuel used



Captures non-residents using in-state EVSE



Tax on volume of fuel used most similar to rationale of current gas tax



Challenges and cost to segmenting electricity in residential setting



If pulling from vehicle, introduces same GPS and tracking concerns

Road Funding Options – EV Fees

Maybe reasonable

EV fees ~~are~~ the worst way to fund roadway infrastructure
aren't



**Lowest
administrative
costs for state to
assess and collect**



**Shortest ramp-up
time to add
revenue to state
budgets**



**Known and
stable
revenue
expectations**



**No GPS
tracking and no
added costs on
infrastructure**

Road Funding Options – EV Fees **AND** kWh Tax

Adding kWh taxes onto DCFC, but not other non-residential Level 2



Captures out-of-state drivers
using state roadway



Avoids double-taxing
in-state drivers via
workplace or
community charging



In-state utilizing
DCFS can be
framed as
convenience tax

Conclusion

- **The auto industry is committed to an electrified future.**
- **As the industry transitions to electrification, there are several challenges that must be addressed**
 - **Vehicle cost, supply chain, charging infrastructure, customers**
- **Necessary conditions – incentives, infrastructure, supply-side economics, and customer awareness – support customers.**
- **Additional collaboration between OEMs, dealers, EVSE companies, utilities, utility commissions, and all relevant stakeholders is necessary**

Key Takeaways

- 1. The auto industry is committed to electrification, but can't do it alone.**
- 2. Regulatory requirements must be aligned with market realities**
- 3. Consumer incentives, charging infrastructure, and EV supply chains need to be established/sustained**
- 4. Complimentary policies – Utility Investments / Public Utility Commission, Building Codes, Clean Fuel Standards / Low Carbon Fuel Standards, etc. – are necessary to make the transition successful.**



ALLIANCE FOR AUTOMOTIVE INNOVATION

Curt Augustine
Senior Director, State Affairs
caugustine@autosinnovate.org